

TOSHIBA



HDD/DVD VIDEO RECORDER

RD-XS52SU RD-XS52SC RD-KX50SU

OWNER'S MANUAL



**INSTALLATION
GUIDE**

Read this booklet first.



Introduction

Connections

Basic Setup

SAFETY PRECAUTIONS

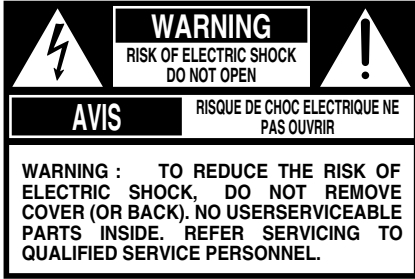

The lightning flash with arrowhead symbol, within an equilateral triangle, is intended to alert the user to the presence of uninsulated “dangerous voltage” within the product’s enclosure that may be of sufficient magnitude to constitute a risk of electric shock to persons.



The exclamation point within an equilateral triangle is intended to alert the user to the presence of important operating and maintenance (servicing) instructions in the literature accompanying the appliance.



The symbol for CLASS II (Double Insulation)

WARNING: TO REDUCE THE RISK OF FIRE OR ELECTRIC SHOCK, DO NOT EXPOSE THIS APPLIANCE TO RAIN OR MOISTURE. DANGEROUS HIGH VOLTAGES ARE PRESENT INSIDE THE ENCLOSURE. DO NOT OPEN THE CABINET. REFER SERVICING TO QUALIFIED PERSONNEL ONLY.

CAUTION: TO PREVENT ELECTRIC SHOCK, MATCH WIDE BLADE OF PLUG TO WIDE SLOT, FULLY INSERT.

ATTENTION: POUR EVITER LES CHOCES ELECTRIQUES, INTRODUIRE LA LAME LA PLUS LARGE DE LA FICHE DANS LA BORNE CORRESPONDANTE DE LA PRISE ET POUSSER JUSQU’AU FOND.

CAUTION: This HDD/DVD video recorder employs a Laser System. To ensure proper use of this product, please read this owner’s manual carefully and retain for future reference. Should the unit require maintenance, contact an authorized service location - see service procedure.

Use of controls or adjustments or performance of procedures other than those specified herein may result in hazardous radiation exposure.

To prevent direct exposure to laser beam, do not try to open the enclosure. Visible and invisible laser radiation when open and interlocks defeated. DO NOT STARE INTO BEAM.

FCC NOTICE: This equipment has been tested and found to comply with the limits for a Class B digital device, pursuant to part 15 of the FCC Rule. These limits are designed to provide reasonable protection against harmful interference in a residential installation.

This equipment generates, uses, and can radiate radio frequency energy and, if not installed and used in accordance with the instructions, may cause harmful interference to radio communications.

However, there is no guarantee that interference will not occur in a particular installation. If this equipment does cause harmful interference to radio or television reception, which can be determined by turning the equipment off and on, the user is encouraged to try to correct the interference by one or more of the following measures:

- Reorient or relocate the receiving antenna.
- Increase the separation between the equipment and receiver.
- Connect the equipment into an outlet on a circuit different from that to which the receiver is connected.
- Consult the dealer or an experienced radio/TV technician for help.

WARNING: Changes or modifications made to this equipment, not expressly approved by Toshiba, or parties authorized by Toshiba, could void the user’s authority to operate the equipment.

Note to cable system installer:

This reminder is provided to call the cable system installer’s attention to Article 820-40 of the NEC that provides guidelines for proper grounding and, in particular, specifies that the cable ground shall be connected to the grounding system of the building, as close to the point of cable entry as practical.

The instructions shall state that an ALL-POLE MAINS SWITCH with a contact separation of at least 3 mm in each pole shall be incorporated in the electrical installation of the building.

CAUTION: These servicing instructions are for use by qualified service personnel only. To reduce the risk of electric shock do not perform any servicing other than that contained in the operating instructions unless you are qualified to do so.

In the spaces provided below, record the Model and Serial No. located on the rear panel of your recorder.

Model No. _____ Serial No. _____

Retain this information for future reference.

Location of the required label

PRODUCT IS CERTIFIED BY THE MANUFACTURER TO COMPLY WITH DHHS RULE 21 CFR SUBCHAPTER J APPLICABLE AT THE DATE OF MANUFACTURE.

MANUFACTURED

TOSHIBA CORPORATION
 1-1,SHIBAURA 1-CHOME,MINATO-KU,
 TOKYO 105-8001,JAPAN

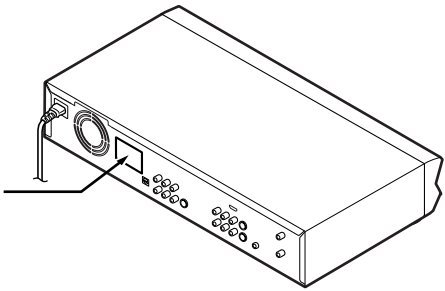

IMPORTANT SAFETY INSTRUCTIONS

1. Read these instructions.
2. Keep these instructions.
3. Heed all warnings.
4. Follow all instructions.
5. Do not use this apparatus near water.
6. Clean only with dry cloth.
7. Do not block any ventilation openings. Install in accordance with the manufacturer's instructions.
8. Do not install near any heat sources such as radiators, heat registers, stoves, or other apparatus (including amplifiers) that produce heat.
9. Do not defeat the safety purpose of the polarized or grounding-type plug. A polarized plug has two blades with one wider than the other. A grounding type plug has two blades and a third grounding prong. The wide blade or the third prong are provided for your safety. If the provided plug does not fit into your outlet, consult an electrician for replacement of the obsolete outlet.
10. Protect the power cord from being walked on or pinched particularly at plugs, convenience receptacles, and the point where they exit from the apparatus.
11. Only use attachments/accessories specified by the manufacturer.
12. Use only with the cart, stand, tripod, bracket, or table specified by the manufacturer, or sold with the apparatus. When a cart is used, use caution when moving the cart/apparatus combination to avoid injury from tip-over.
13. Unplug this apparatus during lightning storms or when unused for long periods of time.
14. Refer all servicing to qualified service personnel. Servicing is required when the apparatus has been damaged in any way, such as power-supply cord or plug is damaged, liquid has been spilled or objects have fallen into the apparatus, the apparatus has been exposed to rain or moisture, does not operate normally, or has been dropped.



ADDITIONAL SAFETY INSTRUCTIONS

15. When you use headphones, keep the volume at a moderate level. If you use the headphones continuously with high volume sound, it may cause hearing damage.
16. Do not overload wall outlets; extension cords, or integral convenience receptacles as this can result in a risk of fire or electric shock.
17. Apparatus should not be exposed to dripping or splashing and no objects filled with liquids, such as vases, should be placed on the apparatus.
18. Keep your fingers well clear of the disc tray as it is closing. Neglecting to do so may cause serious personal injury.
19. Do not place anything on top of this unit.
20. Do not place the apparatus on amplifiers or equipment that may produce heat.
21. Do not cover the ventilating holes for the inside cooling fan.
22. Do not use a cracked, deformed, or repaired disc. These discs are easily broken and may cause serious personal injury and apparatus malfunction.
23. If the apparatus should smoke or smell, immediately disconnect the power cord from the wall outlet. Wait until the smoke or smell stops, then ask your dealer for a check and repair. Neglecting to do so may cause fire.
24. During thunderstorms, do not touch the connecting cables or the apparatus.
25. The apparatus includes lead, an ingredient of solder used on the PCB, which is a harmful substance to human and the environment. When disposing of this apparatus, follow the rules and regulations in your area.

Precautions

Notes on handling

- Never disconnect the power cord from a wall outlet while the recorder is not in standby mode, unless it is in an emergency. Doing so may cause malfunction.
- When shipping the recorder, the original shipping carton and packing materials come in handy. For maximum protection, repack the unit as it was originally packed at the factory.
- Do not use volatile liquids, such as insect spray, near the recorder. Do not leave rubber or plastic products in contact with the recorder for a long time. They will leave marks on the finish.
- The top and rear panels of the recorder may become warm after a long period of use. This is not a malfunction.

When not in use

- For usual absence
Be sure to remove the disc from the recorder and turn off the power.
- Prolonged absence
Unplug the recorder from a wall outlet.

Notes on locating

- Place the recorder on a level surface. Do not use it on a shaky or unstable surface such as a wobbly table or inclined stand. The loaded disc may dislodge from its proper position and cause damage to the recorder. Before placing the recorder, make sure that the surface can stand the weight of the recorder. For safety, avoid placing the recorder in a high location, as an accidental fall of the recorder may cause personal injury.
- When you place this recorder near a TV, radio, or VCR, the playback picture may become poor and the sound may be distorted depending on the condition and location of said equipment. In such an event, place the recorder as far away much as possible from the TV, radio, or VCR.
- Do not install this product in an area where it will be exposed to large amounts of oily smoke, steam or dust, as such exposure could result in fire or electric shock. Cigarette smoke, dust etc. can cause the product to malfunction.

Notes on cleaning

Use a soft, dry cloth for cleaning.

- Do not use any type of solvent, such as thinner or benzene, as they may damage the surface of the recorder.

Notes on antennas

- Image and sound quality depend very much on signal reception.
- Reception may be poor in weak signal areas. In this event, consult your dealer, or purchase a commercially available antenna booster. Refer to the booster's instruction manual for installation details.

Notes on recording and editing

- When you record/edit important content, make trial operations beforehand to confirm the recorder can function properly.
Toshiba does not compensate for content which was not recorded/edited because of some malfunction of this product or discs during operation, and is not liable for incidental damages (such as profit loss or interruption of business, etc.) produced in such conditions.
- When the power cord is disconnected or when a power failure occurs during any operation of this product, all contents recorded in this recorder may be erased.
- Depending on the channel or program, an excessive sound input level may cause noise or cut of recorded sound. Adjust the initial setting of the recording level when necessary.
- If a program you have set a timer recording includes copy restriction signals, it may not be recorded. When programming a recording, confirm that a program you want to record is not copy-restricted.

Exemptions

- Toshiba is not liable for any damage caused by fires, natural disaster (such as thunder, earthquake, etc.), acts by third parties, accidents, owner's intentional or unintentional misuse, or uses in other improper conditions.
- Toshiba is not liable for incidental damages (such as profit loss or interruption in business, modification or erasure of recorded data, etc.) caused by use or inability to use of this product.
- Toshiba is not liable for any damage caused by neglect of the instructions described in the owner's manual.
- Toshiba is not liable for any damage caused by misuse or malfunction through simultaneous use of this product and the connected equipment or software that Toshiba is not concerned with.
- Toshiba does not compensate for contents which were not recorded/edited because of some malfunctions of this product or discs during operation, and is not liable for incidental damages (such as profit loss or interruption in business, etc.) produced by such conditions.

Power Outage

- After a power outage the clock display will flash. Set the clock to the correct time.

Notes on the unit and the HDD

- Do not give a shock or shake (especially during operation).
- Do not use in a shaky or unstable location.
- Hold the unit horizontally.
- Do not cover the ventilation holes for the cooling fan of the unit.
- Do not use in a place where the temperature rises or changes rapidly.
- Do not disconnect the power plug from a wall outlet while the unit is turned on.
- Do not disconnect the power plug from the wall outlet or break the power supply to the unit during recording or playing. Before disconnecting the power plug, be sure to press the power button and make sure the unit ends the finishing process and power turns off completely. If the power plug is disconnected or power supply is disrupted while the unit is recording, all recorded content will be erased.
- Toshiba is not liable for any damage or loss of recorded data caused by shock, shakes, misoperation or malfunction.

Notes on moisture condensation

Moisture condensation damages the unit. Please read the following carefully.

Moisture condensation occurs, for example, when you pour a cold drink into a glass on a warm day. Drops of water form on the outside of the glass. In the same way, moisture may condense on the optical pick-up lens inside this unit, one of the most crucial internal parts of the unit.

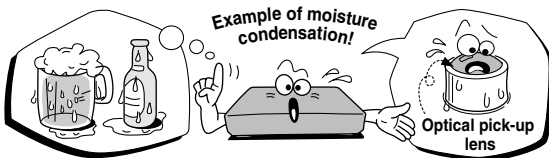

■ **Moisture condensation occurs during the following cases.**

- When you bring the unit directly from a cold place to a warm place.
- When you use the unit in a room where you just turned on the heater, or a place where the cold wind from the air conditioner directly hits the unit.
- In summer, when you use the unit in a hot and humid place just after you move the unit from an air conditioned room.
- When you use the unit in a humid place.

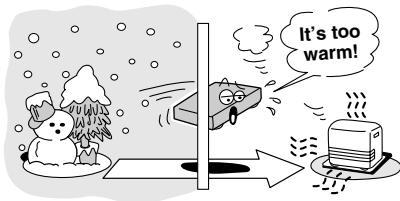

■ **Do not use the unit when moisture condensation may occur.**

If you use the unit in such a situation, it may damage discs and internal parts. Remove the disc, connect the power cord of the unit to the wall outlet, turn on the unit, and leave it for two or three hours. After two or three hours, the unit will have warmed up and evaporated any moisture. Keep the unit connected to the wall outlet and moisture condensation will seldom occur.

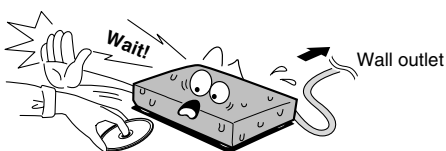

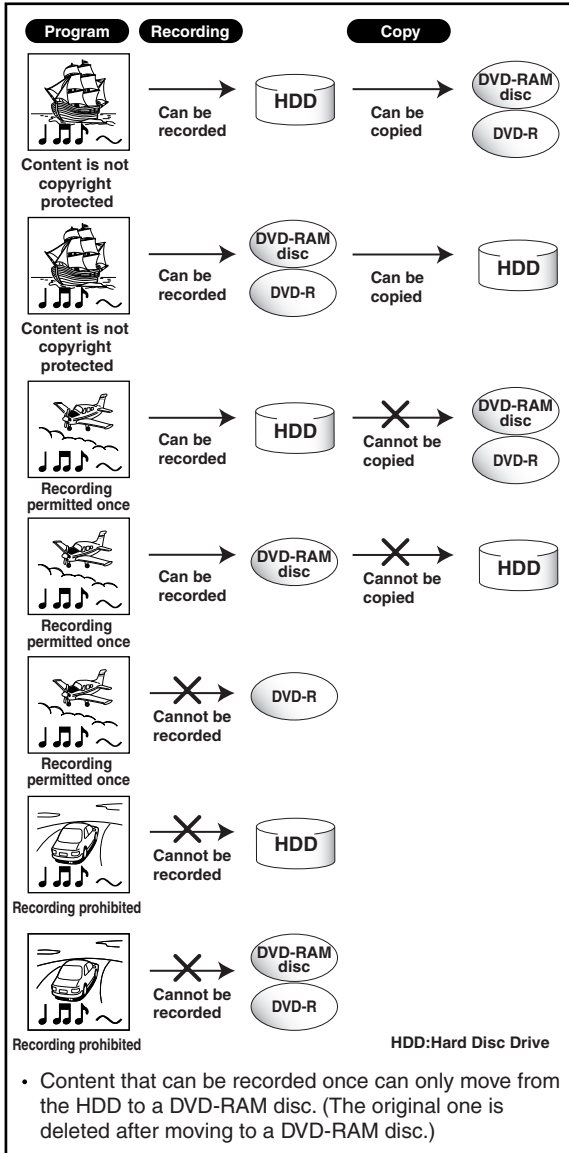

VCR Plus+, C³ and PlusCode are registered trademarks of Gemstar Development Corporation. The VCR Plus+ system is manufactured under license from Gemstar Development Corporation.

Manufactured under license from QSound Labs, Inc. U.S. patent Nos. 5,105,462, 5,208,860 and 5,440,638 and various foreign counterpart. Copyright QSound Labs, Inc. 1998-2002. QXpander™ is a trademark of QSound Labs, Inc. All rights reserved.

Installation procedure

Read carefully “SAFETY PRECAUTIONS”,
“IMPORTANT SAFETY INSTRUCTIONS” and
“Precautions”.
(⇒ pages 2 to 9)

Check the supplied accessories.
(See right)

Load the batteries in the remote control.
(⇒ page 18)

Connect an antenna to the recorder.
(⇒ page 20)
Connect a cable box or satellite system to the recorder.
(⇒ pages 22 to 25)

Connect the recorder to a TV.
(⇒ pages 20 to 21, 28)

Connect optional equipment to the recorder.
(⇒ page 29)

Make the initial settings.
(⇒ page 34)

Your recorder is ready. Read the separate
volume “OPERATIONS GUIDE”.

Accessories

Remote control
Batteries (AAA) x 2

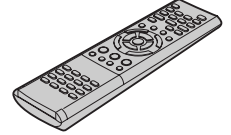

Coaxial cable

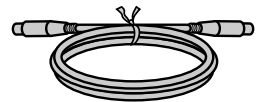

Video/Audio cable

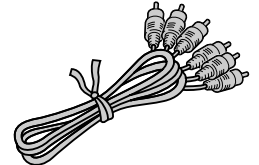

IR control cable

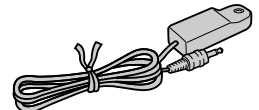

HDMI cable

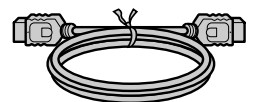

- Owner's manual (INSTALLATION GUIDE)
- Owner's manual (OPERATIONS GUIDE)
- Registration card

About this product

Some differences

Because of its recording capacity and hard disc drive (HDD), this DVD recorder operates more like a computer and differently than a standard DVD player. In addition to containing a microprocessor, it contains a HDD, an operating system, random access memory (RAM), and a DVD-RAM/R drive. The operating system includes software stored on the HDD that is transferred to the RAM when the machine is turned on and at other times during operation. This transfer can take time. Therefore, when you turn the DVD recorder on, it may take a little while before it is ready to use. Likewise, other functions may not be performed as quickly as they would on other AV equipment. Additionally, because programs stored on the DVD-RAM/R drive cannot be accessed as quickly as those stored on the HDD, accessing those programs (or deleting a program from a DVD-RAM disc) may take more time. Please take these factors into consideration as you use the DVD recorder.

About the hard disc drive (HDD)

Like any HDD, the HDD in the DVD recorder is a fragile device that is susceptible to partial or complete failure if it is jarred or as a result of use over time. It will not last forever. Therefore, do not use the HDD for longer term storage of programs you wish to retain. [If portions of the HDD become damaged, programs recorded on those portions may exhibit pixelization or block noise when played back. Repeated playback of the program may cause the problem to get worse and, eventually, the program may become unplayable. Accordingly, if you notice such noise in a program that you want to save, you should transfer to a recordable DVD disc as soon as possible.] Recordable DVD discs are also susceptible to damage if not handled and stored carefully and some or all of the programs on them may become unplayable. You can reduce these risks by using high quality DVD recordable discs and checking their playability from time to time. If it becomes necessary to service your DVD recorder, it may be necessary to delete some or all of the programs on the HDD.

Playback Restrictions

This owner's manual explains the basic instructions for this recorder. Some DVD video discs are produced in a manner that allows specific or limited operation during playback. As such, the recorder may not respond to all operating commands. This is not a defect in the recorder. Please refer to the notes on compatible discs later in this Introduction and to the discussion of DVD playback and features later in this manual.

“Ⓢ” may appear on the TV screen during operation. “Ⓢ” means that the operation is not permitted by the recorder or the disc.

Recording Restrictions and Copyright

Copy-protected contents of DVD-Video discs, VIDEO CDs or audio CDs on the market cannot be copied on this recorder. Contents without copy protection should be copied or edited only in accordance with applicable copyright laws, which may restrict copying or editing. Contents that permit single copying (copy once contents) can be recorded onto DVD-RAM discs, with some dubbing and editing restrictions. DVD-R discs cannot record these contents.

The unauthorized recording, use, distribution, or revision of copyrighted materials including, without limitation, television programs, videotapes, and DVDs, is prohibited under the Copyright Laws of the United States and other countries, and may subject you to civil and criminal liability.

Compatibility

In isolated cases, a disc bearing the DVD or CD logo may not fully and properly play back all features or as intended by the creator of the disc. This can be due, among other reasons, to problems and errors that can occur during the creation or recording of DVD and other software and the manufacture of software discs (including blank discs). Moreover, because of variations in the quality of discs, this recorder may not be able to record on all discs that bear a DVD-RAM or DVD-R logo, but you should not encounter difficulty if you use only high quality recordable DVD discs. Additionally, discs recorded in this device may not operate properly in other DVD players, recorders and/or personal computer drives. If you happen to encounter difficulties playing or recording a DVD disc or playing a CD disc, please feel free to call our Customer Service Hotline at 1-800-319-6684.



Choosing a disc

When you want to play DVD or CD software or copy programs from the HDD to a recordable DVD, load an appropriate disc into the recorder. There are many types and formats of discs. Please use the following information to select an appropriate disc.

Notes

- Handle the disc according to the disc instruction manual.
- Toshiba cannot guarantee that all discs bearing the DVD or CD logos will operate as expected. Additionally, Toshiba cannot guarantee that discs recorded in this device will operate properly in other DVD players, recorders and/or personal computer drives.

For recording / playback

Disc	Mark	Specification	Remarks
DVD-RAM		<ul style="list-style-type: none"> • Single sided 4.7GB (12cm (4³/₄ in.)) • Double sided 9.4GB (12cm (4³/₄ in.)) 	<p>Read carefully the section “On DVD-RAM discs” (➡ page 14).</p> <p>Select a DVD-RAM disc that shows a statement on its package such as “this disc can be used with video recorders and drives compatible with 4.7GB DVD-RAM discs” or “this disc can copy images that permit single copying.”</p>
DVD-R		<ul style="list-style-type: none"> • 4.7GB For General Ver.2.0 (12cm (4³/₄ in.)) 	<p>Read carefully the section “On DVD-R discs” (➡ page 15).</p> <p>Depending on the disc status or the recording equipment, playback of the disc may not be possible on this recorder.</p>

Using different disc types for different purposes

DVD-RAM discs for your personal library

DVD-RAM discs comply with the global standard DVD-VR (Video Recording) format, and are optimized for recording of TV programs. You can rewrite repeatedly without deterioration of an image quality, erase unnecessary parts, divide a chapter, or specify playback area by frame. Its cartridge is suitable for a longer-term storage and family use, and its large capacity of 9.4 GB allows more recording space.











DVD-R discs when creating your own original discs for distribution



DVD-R discs are designed to comply with the global standard DVD-Video format, and can be recorded only once. DVD-R discs are convenient when you edit your original content (recorded personal events such as a wedding party) with this recorder, transfer them to the recorder and make copies to send to your friends or relatives. The discs can be played on other compatible DVD players.

- * DVD-R may not be the best suited format for recording TV programs. Because of the way the discs are formatted, it may not be possible to edit or divide the program as you may prefer, to record secondary languages, or programs that are copy protected in a way that allows only one copy. (NOTE: “Copy once” protected programs generally can be recorded to DVD-RAM discs.)
- * This recorder records on a DVD-R disc in DVD-Video format only.
- * On DVD-R discs, direct recording, copying or the method “Creating a DVD-Video” (➡ page 122 in “OPERATIONS GUIDE”) are available.

We cannot guarantee that DVD-RAM/R discs recorded on this recorder will be playable on all DVD recorders/players. Similarly, there is no guarantee that all DVD-RAM/R discs recorded on other recorders will be playable on this recorder.

For playback only

Disc	Mark	Specification	Remarks
DVD video disc	 	<ul style="list-style-type: none"> • 12cm (4³/₄ in.) / 8cm (3¹/₄ in.) • Region number  or  • Color system: NTSC 	The region number of this DVD recorder is 1. If region numbers, corresponding to a specific playable area, are printed on your DVD video disc and you do not find  or  , or the disc is encoded to permit playback only in regions other than Region 1, disc playback will not be allowed by the recorder.
VIDEO CD		<ul style="list-style-type: none"> • 12cm (4³/₄ in.) / 8cm (3¹/₄ in.) • Color system: NTSC • Version 1.1 and 2.0 	
Audio CD		<ul style="list-style-type: none"> • 12cm (4³/₄ in.) / 8cm (3¹/₄ in.) 	
CD-R		<ul style="list-style-type: none"> • 12cm (4³/₄ in.) • CD-DA (audio CD) format 	Depending on the disc status, playback may not be possible.
CD-RW			

- You cannot play discs other than those listed above.
- You cannot play non-standardized discs even if they may be labeled as above.
- You cannot play discs with specialized encoding (such as SACD discs) or the DVD audio portions of DVD Audio discs.
- This recorder uses the NTSC color system, and cannot play DVD video discs recorded in any other color system (PAL, SECAM, etc.), even if they have region marks  or .
- Toshiba cannot guarantee that all discs bearing the DVD or CD logos will operate as expected. Please see the discussion of compatibility on page 11.

- Toshiba is not liable for any damage or loss caused directly or indirectly by the malfunction of this recorder, including, without limitation, any one of the following:
 - Failure to record contents intended to be recorded by the consumer.
 - Failure to edit contents as intended by the consumer.
 - When a DVD-RAM disc or a DVD-R disc created on this recorder is used (e.g., insertion, playback, recording or editing) in another DVD player, recorder or personal computer drive.
 - When a DVD-RAM disc or a DVD-R disc that is used in the manner described in the immediately preceding bullet point is used again in this recorder.
 - When a DVD-RAM disc or a DVD-R disc that was recorded in another DVD recorder, or in a personal computer drive is used in this recorder.
- Some functions such as Library may not work with personal computer discs.
- Discs recorded in this recorder may not operate as expected on other DVD players, recorders or personal computer drives.

On DVD-RAM discs

■ Use only DVD-RAM discs that comply with DVD-RAM standard Version 2.0 or 2.1.

The recorder cannot record on a disc formatted in any other standard. When using such a disc, initialize it by using the disc-format function of this recorder.

- The recorder may not record, dub, or edit some DVD-RAM discs, because they are edited/recorded with another manufacture's equipment or PC, contain a large number of titles, or have little remaining capacity. Also, a DVD-RAM disc may not be edited or recorded if its title contains still pictures.
- DVD-RAM discs formatted in UDF2.0 on a PC are not compatible with this recorder. Before using these discs, initialize them on this recorder.
- This recorder complies with current copyright protection technology and can copy a disc only when the disc permits copying once. When there is no indication on the disc, copying will not be allowed. Such an indication on a disc is required also for the Library Management database.

■ DVD-RAM discs with cartridges are recommended for recording.

- Two types of DVD-RAM discs are available: ones with cartridges and ones without cartridges. You can use either of them with this recorder, but the former ones are recommended.
- In order to record highly detailed data, make sure the disc is clean. DVD-RAM discs with cartridges are easier to handle in this regard.
- Do not open the cartridge shutter. The disc may not play, or may not be recorded or edited once it becomes dirty.
- There are two types of DVD-RAM cartridges; removable (TYPE 2/4) and not removable (TYPE 1). It is recommended you do not remove the disc even when you can.
Refer to the instruction manual that comes with the disc if it is absolutely necessary to remove the disc.
- Some commercially available cartridge discs cannot be recorded or edited once the inside discs are removed.

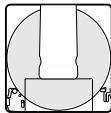

● To protect recorded contents

Slide the write-protect tab to "PROTECT" with something small enough. The disc can play, but cannot be edited or erased. Refer to the instructions that come with the disc.

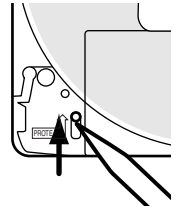

■ When using a disc without a cartridge (commercially available discs)

- Discs without cartridges can easily attract fingerprints and dust, which is the reason they are not recommended. If you cannot avoid using them, handle with proper care.
- When you write in a title column on a disc, use a pen with a soft tip. Do not use a pen with a hard tip, such as a ballpoint pen.

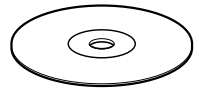

Recommended discs

The following discs have been tested with this recorder:

9.4 GB double-sided cartridge: Panasonic 2x

4.7 GB single-sided cartridge: Panasonic 2x

On DVD-R discs

■ Standards

- DVD-R for General Ver.2.0 discs can be used for recording and playback.
- Discs compatible with 2X speed recording (labeled Ver.2.0/2X etc.) and discs compatible with 4X speed recording (labeled Ver.2.0/4X etc.) can also be used.
- Select discs labeled “for video,” “for recording,” “120 min.” etc.

■ Recording conditions

- Images for which copying is prohibited or restricted (copy once or copy prohibited) cannot be recorded. Even if the disc is labeled as CPRM compatible, this recorder can only be used to record copy-free material.

■ Recommended discs





That's (Taiyo-Yuden) 1x, 4x

■ Tested discs

Panasonic 1x, 4x

Marks on DVD video discs

The following are examples of marks and the meanings.

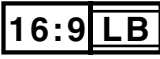
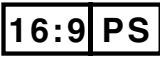
Mark	Meanings
	Number of audio streams recorded in the disc. (2 streams such as English and Japanese in this example.)
	Number of subtitle languages recorded in the disc. (2 subtitle languages are recorded in this example.)
	Number of camera angles recorded in the disc. (3 camera angles are recorded in this example.)
	Pictures are recorded in the standard picture shape (4:3 aspect ratio).
	Pictures are recorded in the letter box picture shape (4:3 aspect ratio with horizontal black bars in the top and bottom of pictures).
	Pictures are recorded in the 16:9 wide picture shape. TVs with 4:3 aspect ratio will display them in the letter box style.
	Pictures are recorded in the 16:9 wide picture shape. TVs with 4:3 aspect ratio will display them in the pan scan style (one or both sides of pictures are cut).
	Actual picture shape may vary depending on the aspect ratio or mode selection of the TV.

Choosing a disc (Continued)

Structure of disc contents

Normally, DVD video discs are divided into titles, and the titles are subdivided into chapters.

VIDEO CDs/audio CDs are divided into tracks.

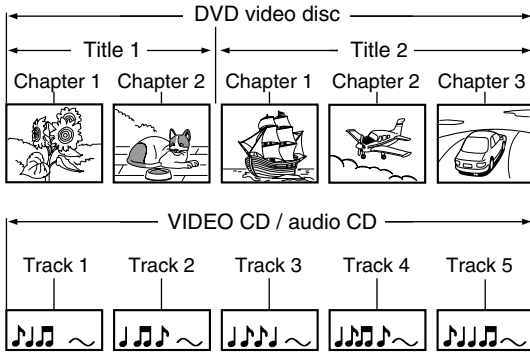

- Title:** Divided contents of a DVD video disc. Roughly corresponds to a story title in short stories.
- Chapter:** Divided contents of a title. This corresponds to a chapter in a story.
- Track:** Divided contents of a VIDEO CD or an audio CD.

Each title, chapter, or track is assigned a number, which is called "title number", "chapter number", or "track number" respectively. Some discs may not have these numbers.

When you record on the HDD or a DVD-RAM disc, one recording will always equal one title. You can divide a title into several chapters by marking borders in it to facilitate scene search.

On handling discs

- Do not touch the playback side of the disc.

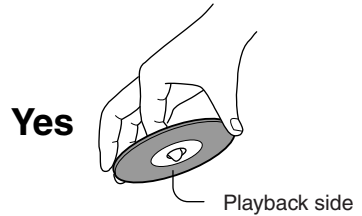

- Do not stick paper or tape to discs.



On cleaning discs

- Fingerprints and dust on the disc cause picture and sound deterioration. Wipe the disc from the center outwards with a soft cloth. Always keep the disc clean.



- Do not use any type of solvent such as thinner, benzene, commercially available cleaners or antistatic spray for vinyl LPs. It may damage the disc.

On storing discs

- Do not store discs in a place subject to direct sunlight or near heat sources.
- Do not store discs in places subject to moisture and dust such as a bathroom or near a humidifier.
- Store discs vertically in a case. Stacking or placing objects on discs outside of their case may cause warping.

Table of Contents

Introduction

■ SAFETY PRECAUTIONS	2
■ IMPORTANT SAFETY INSTRUCTIONS	4
■ Precautions	6
■ Installation procedure	10
■ About this product	11
■ Choosing a disc	12
■ Preparation of the remote control	18

Connections

■ Connecting an antenna and TV	20
■ Connecting to cable TV signal	22
■ Connecting to a satellite system	24
■ Connecting the IR control cable	25
■ Connecting to a TV with the HDMI terminal	26
■ Connecting to a TV equipped with component video inputs	28
■ Connecting to an audio system	29

Basic Setup

■ Starting up the recorder	32
■ A: Initial settings	34
1: Language setting	36
2: Time and date setting	37
3: Channel setting	40
4: Set top box setting	42
5: Guide channel setting	46
■ B: Output sound setting	48
■ C: TV shape setting	50
■ D: Remote control settings	52
Operating a TV with the remote control of this recorder	52
Operating the second and third TOSHIBA HDD/DVD video recorders with the remote control of this recorder	54
■ Limited Warranty DVD PLAYER/RECORDER	56
■ CANADIAN WARRANTY INFORMATION	58

Preparation of the remote control

1 Open the cover.

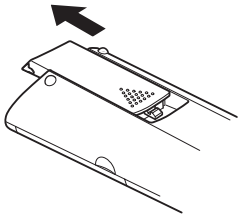

2 Insert batteries (AAA size).

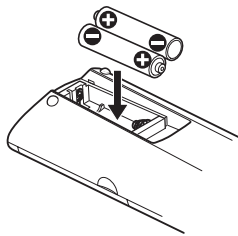

Make sure to match the + and – on the batteries to the marks inside the battery compartment.

3 Close the cover.

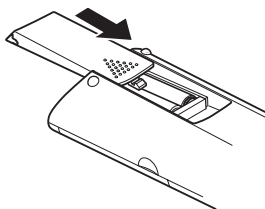

Caution

- Never throw batteries into a fire.

Notes

- Dispose of batteries in a designated disposal area.
- Attention should be drawn to the environmental aspects of battery disposal.
- Do not mix different battery types or combine used batteries with new ones.
- If the remote control does not operate correctly, or if the operating range becomes reduced, replace both batteries with new ones.
- If the batteries are dead or if you will not be using the remote control for a long time, remove the batteries to prevent battery acid from leaking into the battery compartment.

■ Operating with the remote control

Point the remote control at the remote sensor and press the buttons.

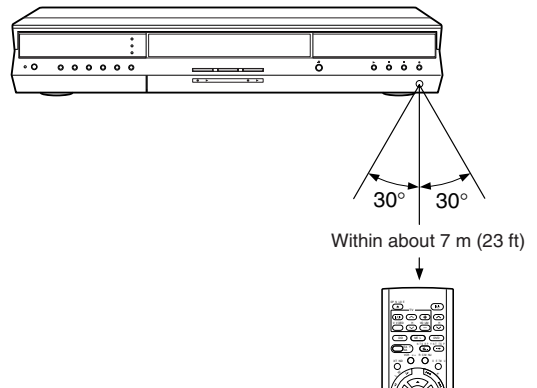

Distance : About 7 m (23 ft) from the front of the remote sensor

Angle : About 30° in each direction of the front of the remote sensor

* Do not expose the remote sensor of the recorder to a strong light source such as direct sunlight or other illumination. If you do so, you may not be able to operate the recorder via the remote control.

Notes

- Direct the remote control at the remote sensor of the recorder.
- Do not drop or give the remote control a shock.
- Do not leave the remote control near an extremely hot or humid place.
- Do not spill water or put anything wet on the remote control.
- Do not disassemble the remote control.



CAUTION: RISK OF EQUIPMENT DAMAGE!

Never plug in any power cords until you have finished connecting all equipment

Connection procedure

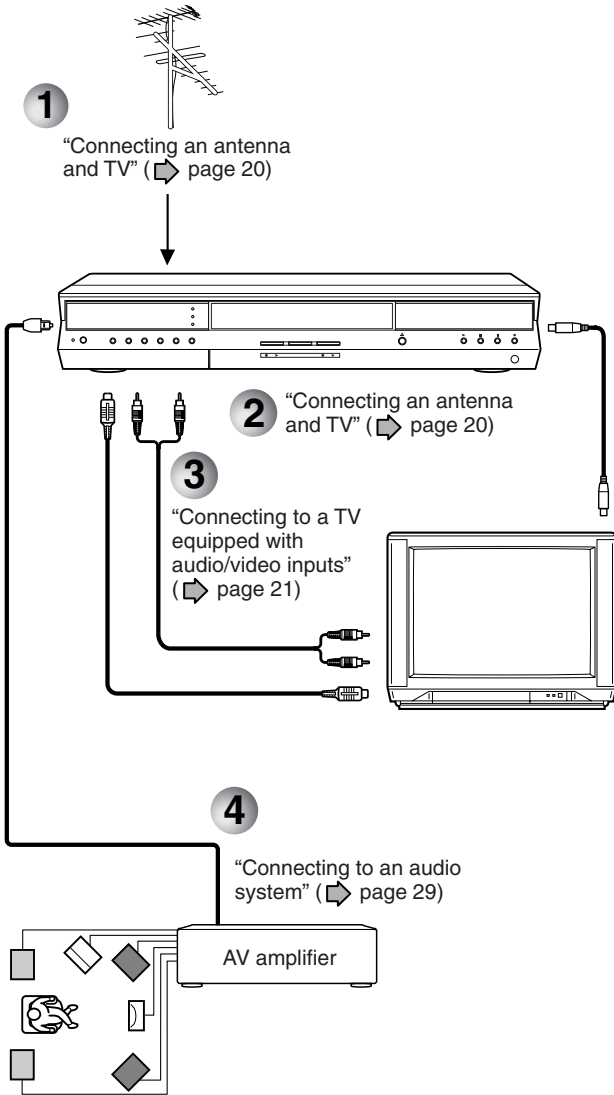

■ **When you connect a TV equipped with audio/video inputs**

Perform steps 1, 2 and 3.

■ **When you connect an audio system**

Perform steps 1, 2, 3 and 4.

Connections

Connect your recorder to your TV or stereo system.

- Connecting an antenna and TV
- Connecting to cable TV signal
- Connecting to a satellite system
- Connecting the IR control cable
- Connecting to a TV with the HDMI terminal
- Connecting to a TV equipped with component video inputs
- Connecting to an audio system

Connecting an antenna and TV

Connect your TV and the antenna to this recorder for recording and to view broadcast signals on the TV.

- 1** Disconnect the antenna cable from your TV, and connect it to the RF IN (FROM ANT.) terminal on the recorder.
- 2** Using the supplied coaxial cable of this recorder, connect the RF OUT (TO TV) terminal to the TV.

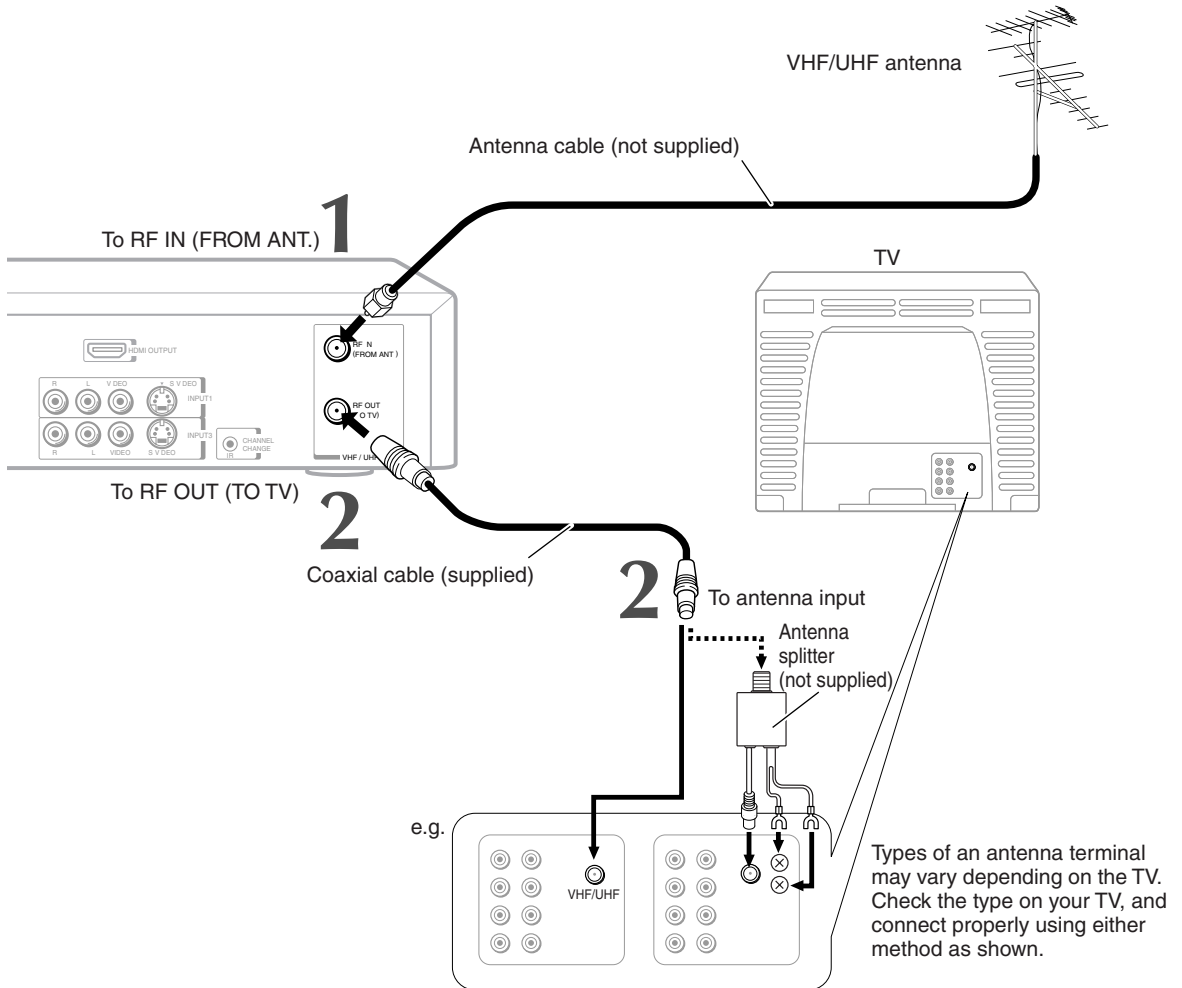

For connecting to a cable box or a satellite system, see ➔ page 22 to 25.

Note

- This connection insures accessibility of broadcast signals to your TV only. Unlike a VCR, you can not assign channel 3 or 4 for playback of this recorder, because an antenna input only passes through in the recorder. You must connect this recorder to a video input of your TV to enjoy playback picture from this recorder. (See the next page.)

3 Connect to a TV equipped with audio/video inputs.

Connect as below for watching received channels or recorded contents. Watching via the RF OUT terminal is not available.

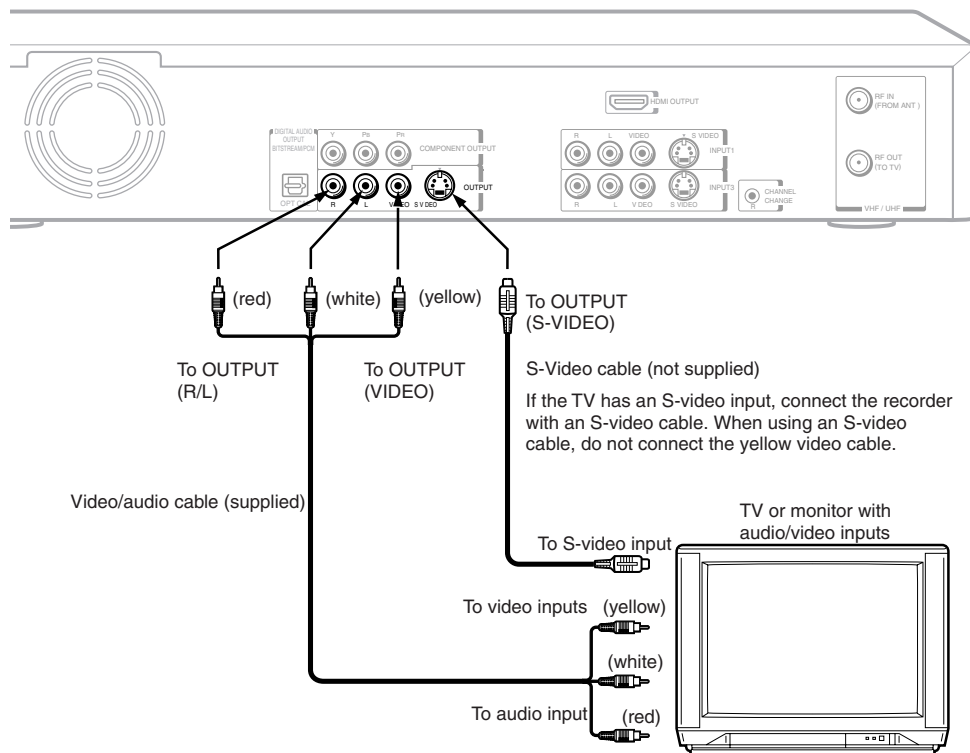

4 Connect the power cord of the recorder to a wall outlet.

Make sure that the powered recorder lights the ON/STANDBY indicator on the front panel.

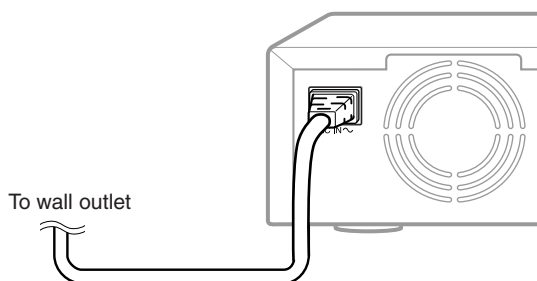

Notes

- Refer to the owner's manual of the connected TV as well.
- When you connect the recorder to your TV, be sure to turn off the power and unplug both units from the wall outlet before any connections.
- If your television set has one audio input, connect the left and right audio outputs of the recorder to a Y cable adapter (not supplied) and then connect to your TV.
- Connect the recorder directly to your TV. If you connect the recorder to a VCR, TV/VCR combination, video selector or AV amplifier, the playback picture may be distorted due to copy protection.

Connecting to cable TV signal

Choose one of the below according to your usage of the cable box.
 For watching received channels, connect to the TV via the audio/video cable.

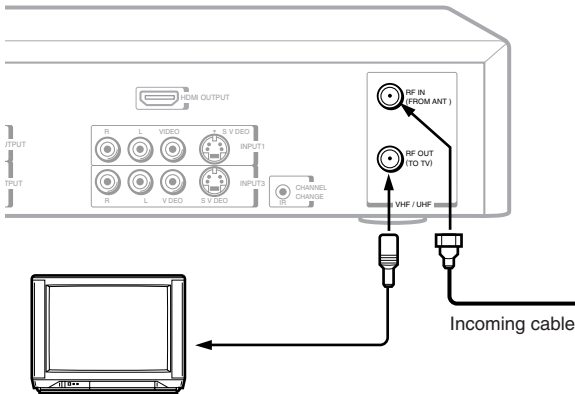

This set-up will allow you to:

- record an unscrambled channel.
- record an unscrambled channel while watching another (only when you connect a cable-compatible TV).

You will need to:

- to record a channel while watching another, select a desired channel on the TV (only when you connect a cable-compatible TV).

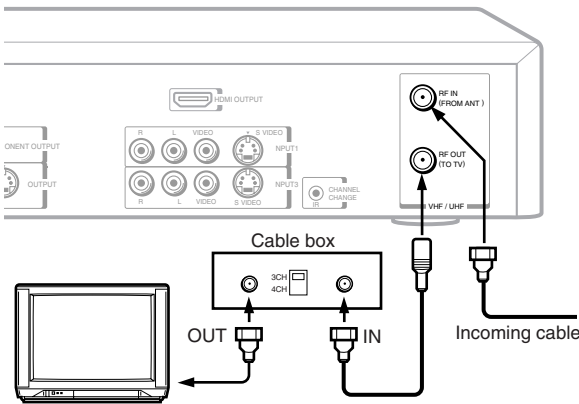

This set-up will allow you to:

- record an unscrambled channel.
- record an unscrambled channel while watching another (scrambled or unscrambled).

You will need to:

- set TV channel to the output channel of the cable box.
- to record an unscrambled channel while watching a scrambled channel, select a desired cable channel via the cable box.

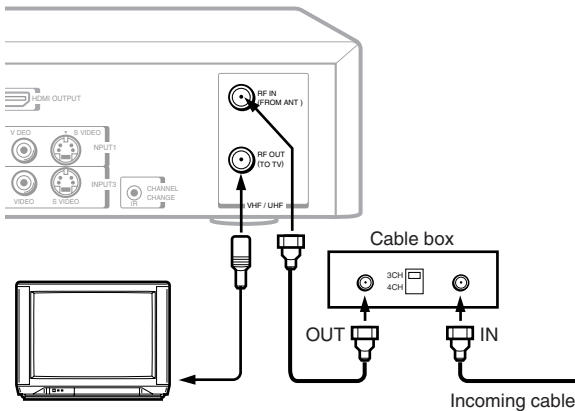

This set-up will allow you to:

- record any channels through the cable box.

You will need to:

- set “Cable Box/DBS” of “Set Top Box setting” to “C.Box”. ➡ page 42
- set “Select input” of “Set Top Box setting” to “3CH” or “4CH”. ➡ page 42
- select a desired cable channel via the cable box.
- while the recorder is turned off, set TV channel to the output channel of the cable box.

You can control cable channels from the recorder. Perform the below.

- 1) Connect the supplied IR cable to the CHANNEL CHANGE IR jack of the recorder. ➡ page 25
- 2) Set “IR control” of “Set Top Box setting” to “On”. ➡ page 42

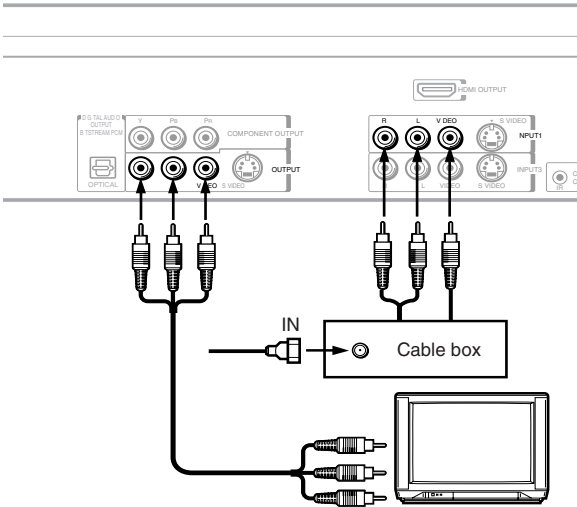

This set-up will allow you to:

- watch or record a channel through the cable box via the INPUT1 or INPUT3 (VIDEO/L/R) jacks.

You will need to:

- set "Cable Box/DBS" of "Set Top Box setting" to "C.Box". ➡ page 42
- set "Select Input" of "Set Top Box setting" to "Line1". ➡ page 42

You can control cable channels from the recorder. Perform the below.

- 1) Connect the supplied IR cable to the CHANNEL CHANGE IR jack of the recorder. ➡ page 25
- 2) Set "IR control" of "Set Top Box setting" to "On". ➡ page 42

Connecting to a satellite system

Choose one of the following according to your type of satellite receiver.

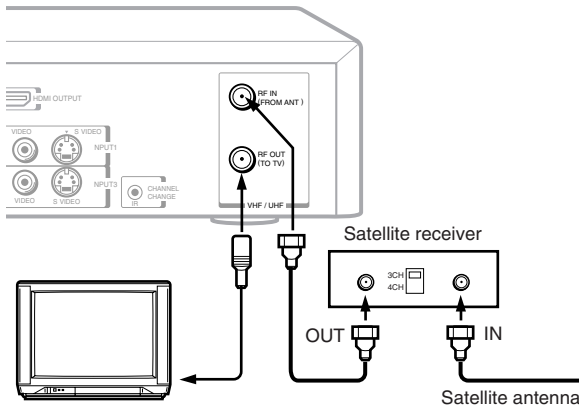

When the satellite receiver does not have audio/video outputs

- 1 Connect a satellite antenna to the satellite receiver.
- 2 Connect the RF IN (FROM ANT.) terminal on the recorder and the RF OUT terminal of the satellite receiver.
- 3 Connect the RF OUT (TO TV) terminal on the recorder and the antenna input connector of the TV.

You will need to:

- set “Cable Box/DBS” of “Set Top Box setting” to “C.Box”. ➡ page 42
- set “Select Input” of “Set Top Box setting” to “3CH” or “4CH”. ➡ page 42

You can control satellite channels from the recorder. Perform the below.

- 1) Connect the supplied IR cable to the CHANNEL CHANGE IR jack of the recorder. ➡ page 25
- 2) Set “IR control” of “Set Top Box setting” to “On”. ➡ page 42

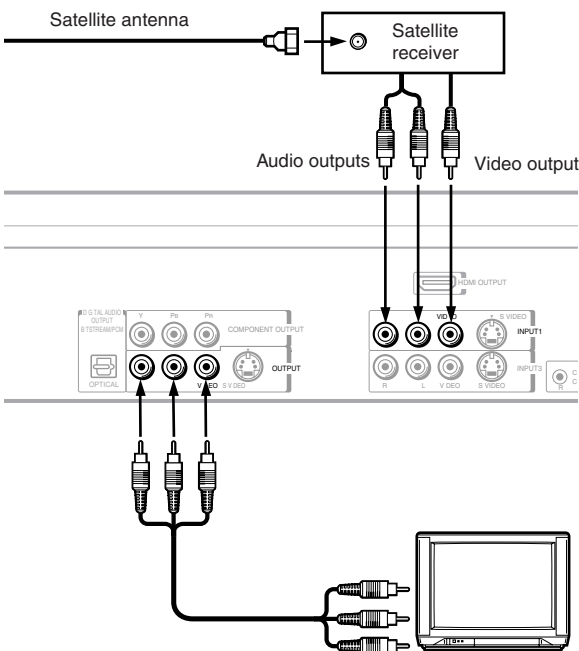

When the satellite system has audio/video outputs

- 1 Connect a satellite antenna to the satellite system.
- 2 Connect the INPUT1 or INPUT3 (VIDEO/L/R) jacks on the recorder and the audio/video output jacks of the satellite system.
- 3 Connect the OUTPUT (VIDEO/L/R) jacks on the recorder and the audio/video input jacks of the TV.
- 4 Connect the RF OUT (TO TV) terminal on the recorder and the antenna input connector of the TV.

You will need to:

- set “Cable Box/DBS” of “Set Top Box setting” to “C.Box”. ➡ page 42
- set “Select Input” of “Set Top Box setting” to “Line1”. ➡ page 42

You can control satellite channels from the recorder. Perform the below.

- 1) Connect the supplied IR cable to the CHANNEL CHANGE IR jack of the recorder. ➡ page 25
- 2) Set “IR control” of “Set Top Box setting” to “On”. ➡ page 42

Connecting the IR control cable

The recorder sends commands to your connected set top box to control the channels of it through the IR control cable. Follow the instruction below.

- 1** Connect the plug of the supplied IR control cable to the **CHANNEL CHANGE IR jack** on the recorder.
- 2** Place the transmitter near the set top box connected to the recorder.

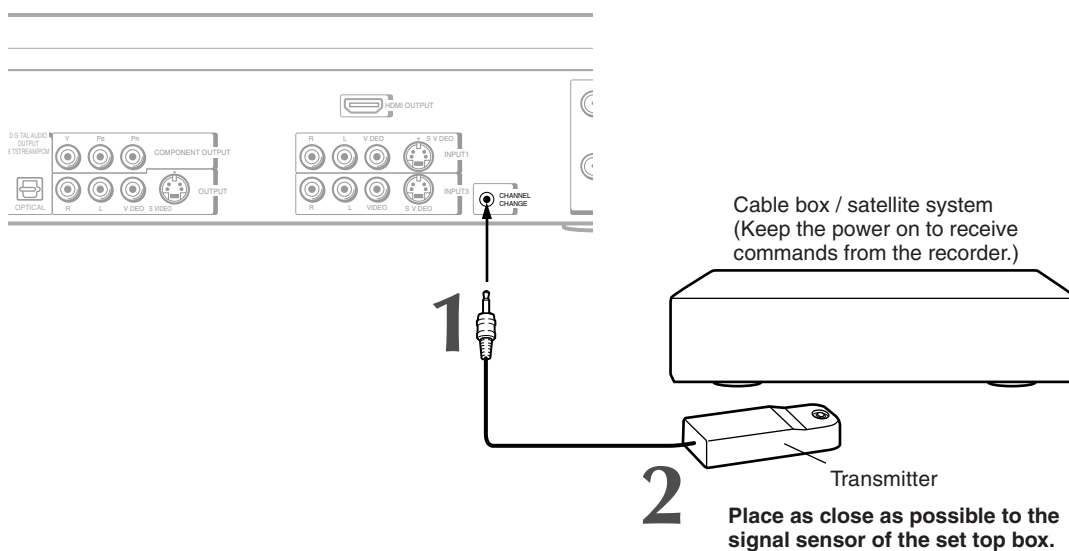

After connecting, make the necessary setting (➡ page 42).

When you use the recorder for the first time, also make the other settings (➡ page 34).

Notes

- Do not connect an accessory other than the supplied IR control cable to the CHANNEL CHANGE IR jack.
- Do not cover the transmitter.
- The recorder sends commands even while it is turned off.
- Refer to the owner's manual of the connected set top box as well.

Connecting to a TV with the HDMI terminal

About HDMI™

HDMI stands for High Definition Multimedia Interface. HDMI transfers digital audio and uncompressed digital video on a single cable. As a result, audio cables and video cables don't need to be connected separately to a device. In addition, HDMI is compatible with HDCP (High Bandwidth Digital Content Protection).

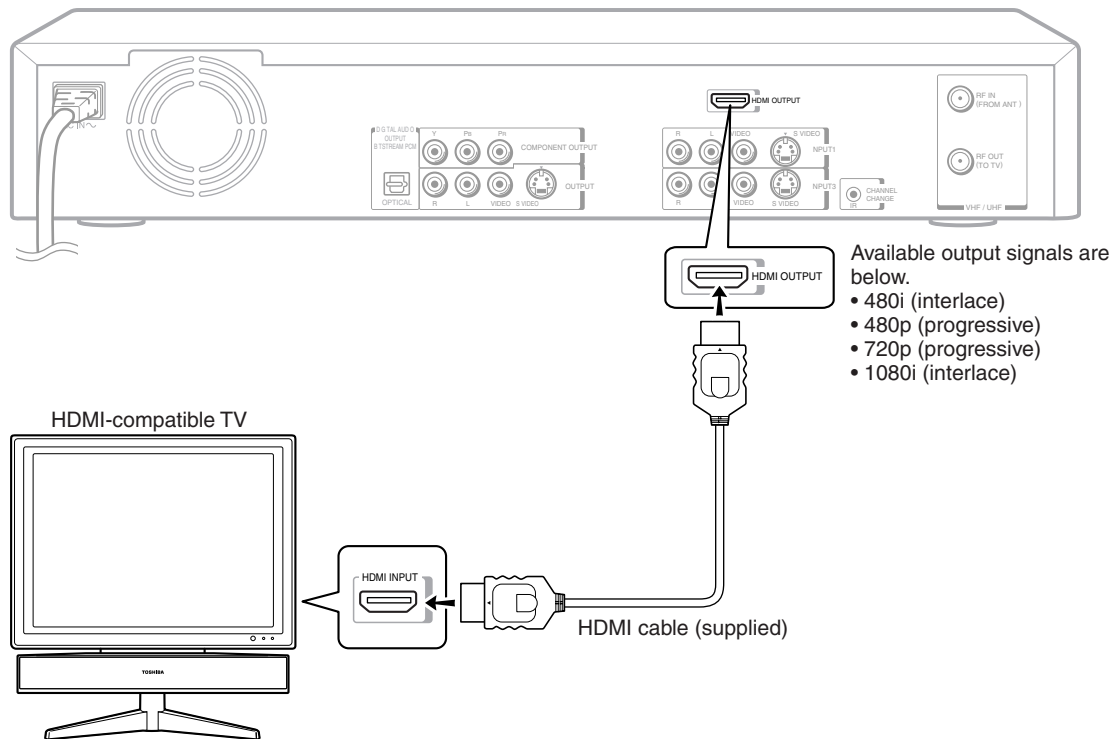

Notes

- Refer to the owner's manual for the TV to be connected to this recorder for more information concerning HDMI connections.
- When the HDMI connection is not verified, the error message appears on the screen or the front panel display. Depending on content, the message doesn't appear on the screen with only the HDMI connection. To see the error message, connect your TV to Video output or S-Video output.
- When the HDMI connection is not verified, content that can only be recorded one time and content that can never be recorded cannot be played back on a HDMI-compatible TV through this recorder (content that is not copyright protected can be played back.).
- HDMI connections with this recorder is not available with VGA output.
- Connect directly your TV with this recorder. When your TV is connected with the recorder via other device such as an amplifier or selector, the HDMI connection may not function properly.
- HDMI is an evolving technology, so it is possible that some devices may not operate properly with this recorder.
- When the HDMI connection is used, the startup screen which is displayed on the screen when the recorder is turned on does not appear on your TV.

Set the output resolution for the HDMI output that best matches your TV's capabilities

Set an output signal from the HDMI terminal of the recorder in accordance with your TV's input signal.

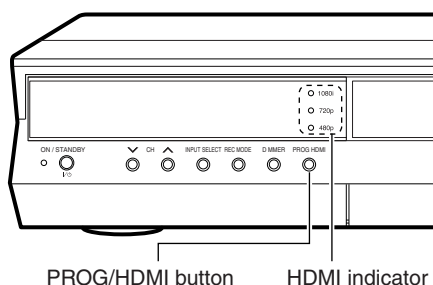

Pressing PROG/HDMI button on the front panel or the remote control changes output signals as below. See the HDMI indicator and select the appropriate output signal.

HDMI indicator	Video output signal
illuminates "● 1080i"	1080i (interlace)
Press	
illuminates "● 720p"	720p (progressive)
Press	
illuminates "● 480p"	480p (progressive)
Press	
off	480i (interlace)

480p, 720p and 1080i are signals created with this recorder from original 480i signal. The resolution of the picture may not be increased even if they are selected.

Note

- PROG/HDMI button is not available during the operations below.
 - All HDD title delete
 - TIME SLIP (Pause TV/Chase Play)
 - HDD format
 - Rate conversion dubbing (Only when copying is in progress.)
 - DVD-RAM physical format
 - DVD-Video creation (EDIT MENU)
 - DVD format (Only when copying is in progress.)
- (PROG/HDMI button may not be available during some other operations either.)

Audio setting for the HDMI connection

The HDMI connection will only output "PCM".

Set "Audio out select" of "Picture/Audio setting" to "PCM" (➡ page 48).

Note

- When the HDMI connection is used, "Black level", "Custom picture select" and "Custom picture setting" of "Picture/Audio settings" are not available.

HDMI, the HDMI logo and High-Definition Multimedia Interface are trademarks or registered trademarks of HDMI licensing LLC.

Connecting to a TV equipped with component video inputs

If your TV has component video inputs, you can obtain pictures in better quality.

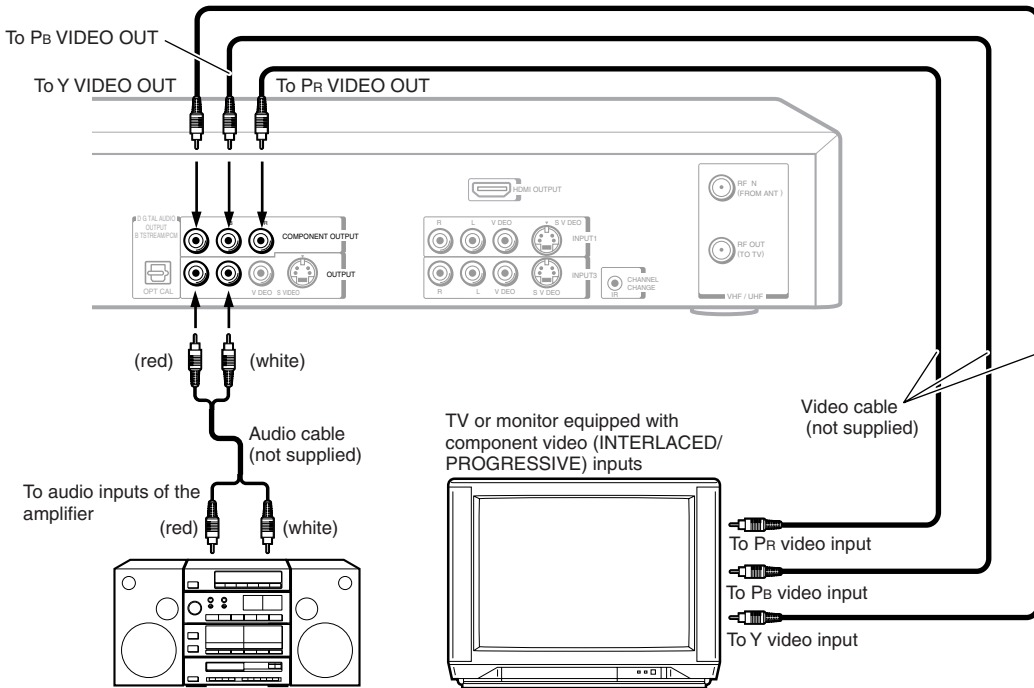

Component video outputs/inputs

Some TVs or monitors are equipped with component video inputs. Connecting to these inputs allows you to enjoy higher quality picture playback.

Actual labels for component video inputs may vary depending on the TV manufacturer. (ex. Y, R-Y, R-B or Y, C_B, C_R)

In some TVs or monitors, the color levels of the playback picture may be reduced slightly or the tint may change. In such a case, adjust the TV or monitor for optimum performance.

- Make the following setting.

On-screen display	Select	Page
"Audio out select"	"Analog 2ch"	➡ page 48

Notes

- Refer to the owner's manual for the TV to be connected to this recorder for more information concerning an audio system.
- If you place the recorder near a tuner or radio, the radio broadcast sound might be distorted. In this case, place the recorder away from the tuner and radio.
- The output sound of the recorder has a wide dynamic range. Be sure to adjust the audio amplifier's volume to a moderate listening level. Otherwise, the speakers and your hearing may be damaged by sudden high volume sound.
- Turn off the amplifier before you connect or disconnect the recorder's power cord. If you leave the amplifier power on, the speakers may be damaged.
- PROG/HDMI button is not available during the operations below.
 - All HDD title delete, HDD format, DVD-RAM physical format, DVD format, TIME SLIP (Pause TV/Chase Play), Rate conversion dubbing (Only when copying is in progress.), DVD-Video creation (EDIT MENU) (Only when copying is in progress.) (PROG/HDMI button may not be available during some other operations either.)

To switch the output signal (Progressive/Interlaced)

Press PROG/HDMI button to change the video output signals (progressive and interlace) from COMPONENT OUTPUT jacks. Change the output signals as shown on the HDMI indicator on the front panel.

HDMI indicator	Video output signal
----------------	---------------------

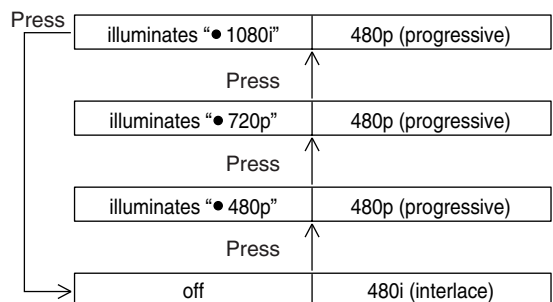

Connecting to an audio system

You can enjoy multichannel surround-sound such as 5.1 channel by connecting to an amplifier compatible with Dolby Digital and DTS sound.

- For connection to your TV, see ➔ pages 20 to 21, 28.
- For details of output sound, see ➔ page 75 in “OPERATIONS GUIDE”.

Caution

- When you are connecting (via the DIGITAL AUDIO OUTPUT BITSTREAM/PCM jack) an AV decoder that does not have Dolby Digital, Digital Theater Systems (DTS) or MPEG2 decoding function, be sure to set “Audio out select” to “PCM” from the on-screen displays (➔ page 48). Otherwise, high volume sound may damage your hearing as well as the speakers.
- When playing DTS-encoded discs (DVD video discs and audio CDs), excessive noise may be output from the analog stereo jacks. To avoid possible damage to the audio system, you should take proper precautions when the analog audio out (L/R) jacks of the recorder are connected to an amplification system. To enjoy DTS Digital Surround® playback, an external 5.1 channel DTS Digital Surround® decoder system must be connected to the DIGITAL AUDIO OUTPUT BITSTREAM/PCM jack of the recorder.

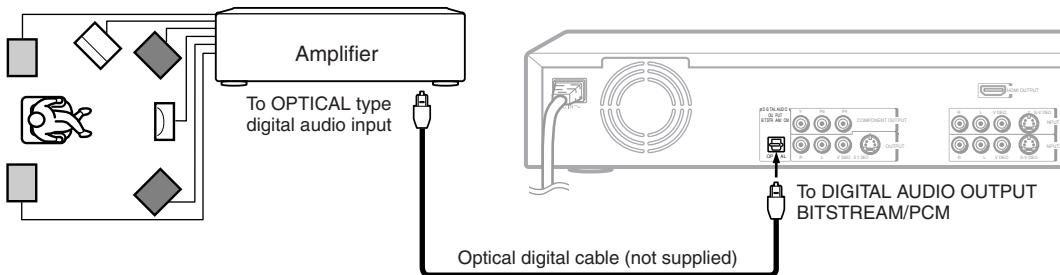

Manufactured under license from Dolby Laboratories. “Dolby” and the double-D symbol are trademarks of Dolby Laboratories.

“DTS” and “DTS Digital Out” are trademarks of Digital Theater Systems, Inc.

- Make the setting on ➔ page 48, “Audio out select”.

Notes

- DO NOT connect the DIGITAL AUDIO OUTPUT BITSTREAM/PCM jack of the recorder to the AC-3 RF input of a Dolby Digital Receiver. This input on your A/V Receiver is reserved for Laserdisc use only and is incompatible with the DIGITAL AUDIO OUTPUT BITSTREAM/PCM jack of the recorder.
- Connect the DIGITAL AUDIO OUTPUT BITSTREAM/PCM jack of the recorder to the “OPTICAL” input of a Receiver or Processor.
- Refer to the owner’s manual for the TV to be connected to this recorder for more information concerning connecting an audio system.
- The output sound of the recorder has a wide dynamic range. Be sure to adjust the audio amplifier’s volume to a moderate listening level. Otherwise, the speakers and your hearing may be damaged by a sudden high volume sound.
- Turn off the amplifier before you connect or disconnect the recorder’s power cord. If you leave the amplifier power on, the speakers may be damaged.

Basic Setup

Read this chapter for necessary settings to get started. When you use this recorder for the first time, be sure to perform A to C in this order. Proceed to D if necessary.

- **Starting up the recorder**

- **A: Initial settings**

- **Language setting**

- **Time and date setting**

- **Channel setting**

- **Set top box setting**

- **Guide channel setting**

- **B: Output sound setting**

- **C: TV shape setting**

- **D: Remote control settings**

- **Operating a TV with the remote control of this recorder**

- **Operating the second and third TOSHIBA HDD/DVD video recorders with the remote control of this recorder**

Starting up the recorder

After all the necessary connections,

- Turn on the equipment connected to the recorder.
- Select the corresponding video input on your television.

Perform these selections whenever you operate the recorder.

■ Turning the power on

Press ON/STANDBY button from the remote control or on the front panel of the recorder.

ON/STANDBY button

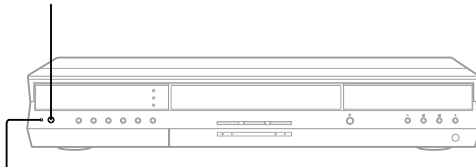

ON/STANDBY indicator

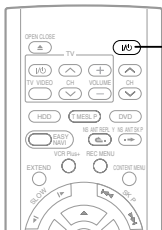

ON/STANDBY button

When the power turns on, ON/STANDBY indicator changes color from red (standby mode) to green (operation).

After a few seconds, a startup screen appears.

The following icon will appear on the top right corner of the screen. The icon will continue flashing momentarily.

e.g.



While the icon is flashing, the recorder is checking the status and reading data of the HDD and the DVD drive for startup. If the DVD drive does not contain a disc, the recorder consumes less time to startup, because it does not need to read data from the DVD drive.

While the "Loading" icon is flashing, the recorder cannot respond to any operations of buttons other than CH and INPUT SELECT. Operate all other functions after the icon has disappeared.

Note

- When the recorder is turned on for the first time, the following menu will be displayed after the "Loading" icon has disappeared. See "A: Initial settings" (➡ page 34).

e.g.

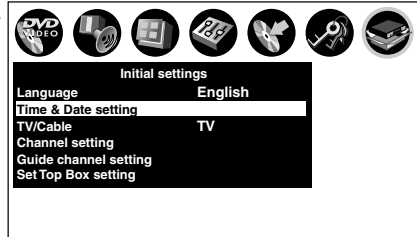

■ Turning the power off

Press ON/STANDBY button from the remote control or on the front panel of the recorder.

The "Unloading" icon appears on the right corner of the top of the screen, and the ON/STANDBY indicator turns red. Then the power turns off.

Note

- If the recorder freezes for about 15 minutes and will not respond to any buttons, holding down ON/STANDBY button on the front panel for about 10 seconds can force the recorder to turn off. However, this is an emergency measure, which contains a risk of damage to data or discs. Avoid casual use of this measure. If you try this while the recorder is operating properly, especially while the "Loading" or "Unloading" icon is flashing, it may result in re-initialization of the HDD.

■ Startup/finishing (closing) icons

These icons are displayed on the right corner on the top of the screen. While they are flashing, the recorder is operating as follows:



Startup, reading a disc, finishing recording



Unloading a disc, finishing the recorder's operation



Opening a disc tray



Closing a disc tray

A: Initial settings

This step sets the recorder's clock and tuner to record broadcasting TV programs. Once you complete this process there is generally no need to reset the clock. (However, if there are discrepancies in the recorder's time display or changes made to receivable TV stations, you should make this setting again.)

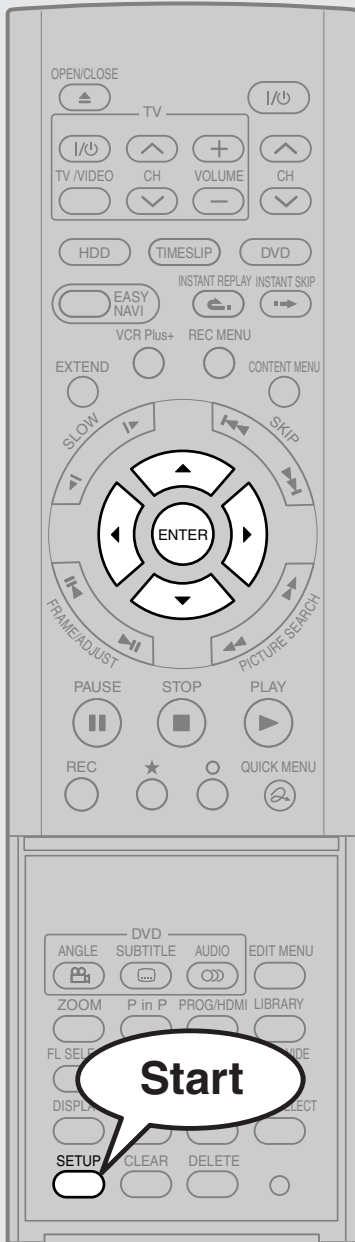

When the recorder is operated for the first time, begin from step 3.

1 Press **SETUP**.

2 Press **◀/▶** to select “Initial settings”, then press **ENTER**.

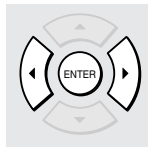

e.g.

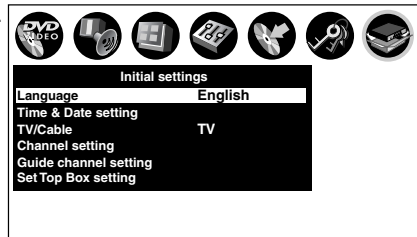

3 Press **▲/▼** to select the setting to be adjusted, then press **ENTER**.

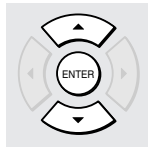

The submenu appears.

e.g. When “Time & Date setting” is selected:

e.g.

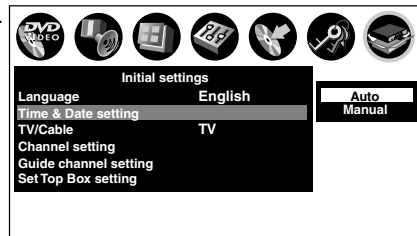

When the recorder is operated for the first time, input settings in the following order.

- 1: Language setting → page 36
- 2: Time and date setting → page 37
- 3: Channel setting → page 40
- 4: Set top box setting → page 42
- 5: Guide channel setting → page 46

Notes

- To go back to the previous menu, press **○** button.
- To exit the menu, press **SETUP** button.
- If you exit “Initial settings” menu without setting the clock and channels, a menu may automatically appear to remind you to set them each time you turn on the recorder. Once you complete this process, the menu reminder will not appear again.

Tip on setting

The recorder provides you with a variety of GUI (Graphical User Interface) displays to perform key operations including customizing of setting, playback or recording.

Refer to the guide on the bottom on each GUI for further programming related information.

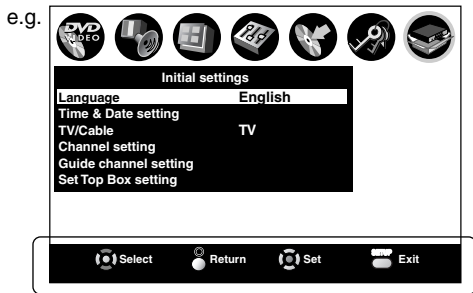

Operation guide

Example of the icon

Function



Direction buttons

To select an item.



O button

To return to the previous page.



ENTER button

To enter (confirm) a selected item or setting.



SETUP button

To display/exit a setting menu.

If a message appears

The recorder may display a message. Each message varies according to operational status.

To respond, follow the examples below.

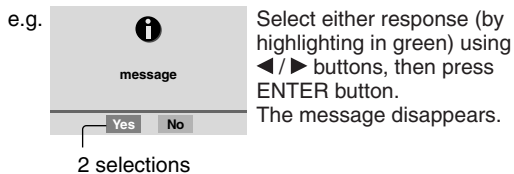
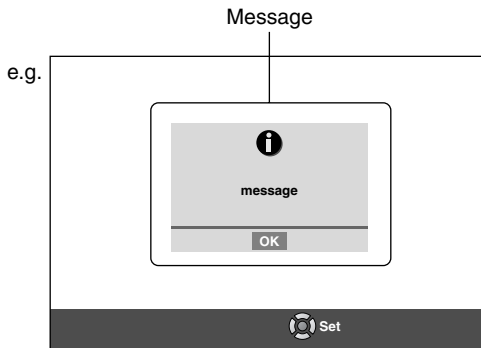

Select either response (by highlighting in green) using ◀/▶ buttons, then press ENTER button. The message disappears.

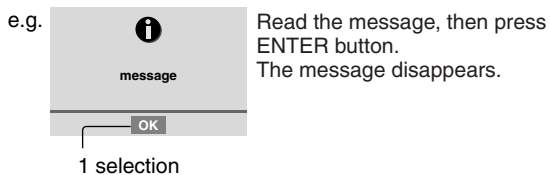

Read the message, then press ENTER button. The message disappears.

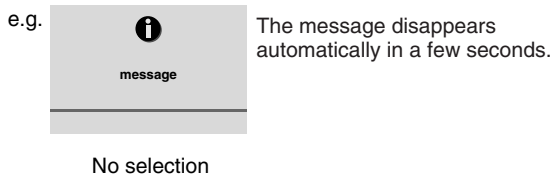

The message disappears automatically in a few seconds.

1: Language setting

Select a preferred language for on-screen displays.

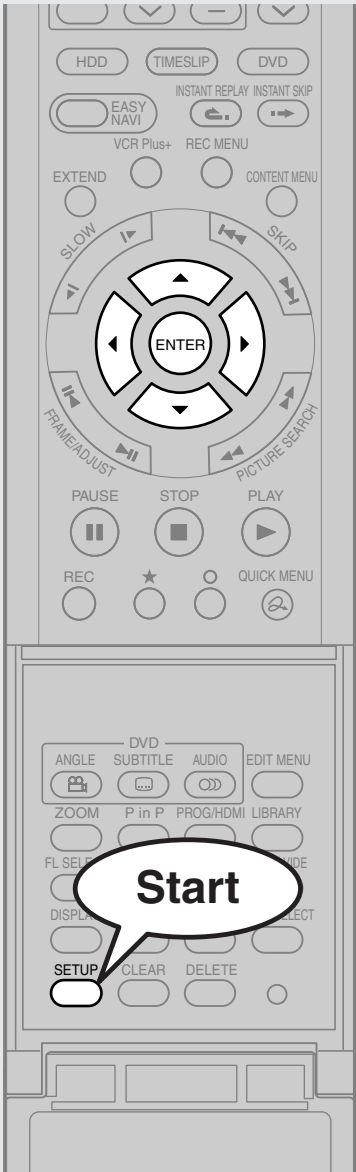

1 Press **SETUP**.

2 Press **◀/▶** to select “Initial settings”, then press **ENTER**.

3 Press **▲/▼** to select “Language”, then press **ENTER**.

e.g.

Initial settings	
Language	English
Time & Date setting	
TV/Cable	TV
Channel setting	
Guide channel setting	
Set Top Box setting	

4 Press **▲/▼** to select a language, then press **ENTER**.

English: To view on-screen displays in English.

French : To view on-screen displays in French.

“1: Language setting” is complete. Go to “2: Time and date setting”. (➡ page 37)

2: Time and date setting

Set the recorder's clock. If it is not set correctly, the recorder cannot perform operations other than playback.



When the recorder is operated for the first time, begin from step 3.

1 Press **SETUP**.

2 Press **◀/▶** to select “Initial settings”, then press **ENTER**.

3 Press **▲/▼** to select “Time & Date setting”, then press **ENTER**.

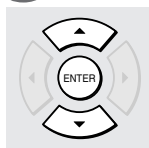

e.g.

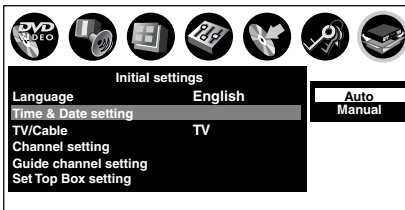

4 Press **▲/▼** to select “Auto” or “Manual”, then press **ENTER**.

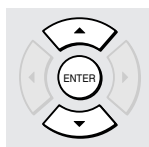

Auto : The recorder will set the time and date. Proceed to step 5. (This is not a self-correcting function.)

Manual : You can set the clock manually. See “Manual clock setting” ➔ page 39

Select “Manual” to set the clock if not set correctly by “Auto”.

Auto clock setting

5 Press **◀/▶** to select an item, then press **ADJUST** (or **▲/▼**) to select a detailed setting.

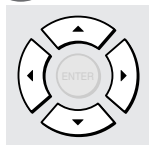

e.g.

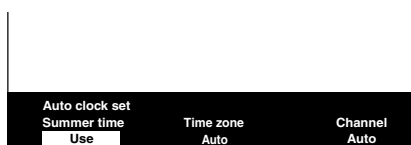

A: Initial settings (Continued)

Notes on summer time on this recorder

- The recording system of this recorder always conforms to its own actual clock even at the moment it gains or loses 1 hour of shift to/from summer time. Therefore, there may be some inconsistency in the display's digits or actual operations on that occasion. For example, on the first Sunday in April, the actual recording length of a programmed recording from 1:00 a.m. to 4:00 a.m. will be 2 hours, not 3. Be sure to give a careful consideration to your setting or reading on-screen if a recording period includes the moment of time shift.
- This recorder's clock cannot lose 1 hour on the last Sunday in October even if you set "Auto" or "Use" at step 5, unless it once gained 1 hour in April.



1) Set "Summer time (Daylight-Saving time)".

DST start : Daylight-saving time begins on the first Sunday in April. The internal clock automatically changes from 2:00 AM to 3:00 AM (forward one hour).

DST end : Daylight-saving time ends on the last Sunday in October. At 2:00 AM the recorder clock automatically changes to 1:00 AM (back one hour).

Auto : The recorder uses clock data Broadcast by the local (PBS) TV stations.

Use : You want to use the DST function, and you are living in an area that applies Daylight-saving time.

No Use : You are not living in the area where Daylight-saving time applies and you do not want to use DST function.

2) Set "Time zone".

If you select "Auto" for your time zone, the recorder sets the clock using the first Coordinated Universal Time information it finds. If the auto set time is not correct, select another time zone or use the "Manual" option.

3) Set "Channel". (While displaying a channel number, the number buttons are also available to change it.)

If you do not know the clock data channel, select "Auto". The recorder will scan automatically to tune the channel carrying the clock data. (generally a PBS station)

If you select this when "IR control" is "On" (➡ page 42), the recorder searches 1 - 70 ch of the set top box connected to the input which you set at "Select input" (➡ page 42).

- Depending on the signal condition, the recorder may take a longer time to set the clock.

Select "Channel" to set the clock if not set correctly by "Auto".

6 Press ENTER.



The clock setting starts. The display returns to the previous screen after setting is completed. Auto Clock Setting may take a long time. If Auto clock setting is unsuccessful, input the time and date via the "Manual" clock setting menu selection.

Notes

- If you set "Summer time (Daylight-Saving time)" to "Auto" and "Time zone" to "Manual", a small time discrepancy may occur around the hours of DST start/end.
- Even if "Time & Date setting" is set to "Auto," a time discrepancy within 1 second should be inevitable.
- When setting both "Time & Date setting" and "Time zone" to "Auto", you can confirm the set "Time zone" in the "Time zone" display of the "Manual" screen in "Time & Date setting". (The "Time zone" display of the "Manual" screen in "Time & Date setting" will remain in "Auto".)
- In the case of a programmed recording with the DST change-over point to Daylight-saving time, if the continuous recording time exceeds the limit due to a time discrepancy caused by Daylight-saving time during recording, the recording stops on that point.

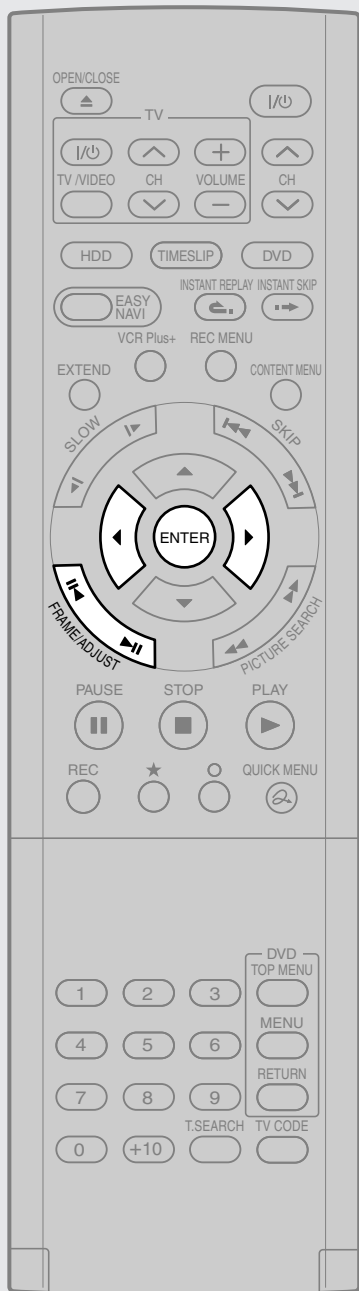

Manual clock setting

Select "Manual" at step 4 → page 37.

e.g.

Manual clock set					
Year	Date	Time	am/pm	Summer	Time zone
2004	10 / 24 (Su)	6 : 15	pm	Use	Hawaii

4 Press ◀/▶ and ADJUST (◀◀/▶▶) to set the clock.

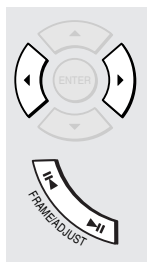

◀/▶ buttons:

To select "Year", "Date", "Time", "am/pm", "Summer (Summer time)" or "Time zone".

ADJUST (◀◀/▶▶) buttons:

To change the data.

(▲/▼ buttons can also be used in addition to ADJUST (◀◀/▶▶) buttons.)

5 After setting all the items, press ENTER.



The following message appears.



6 Press ◀/▶ to select "Yes", then press ENTER.

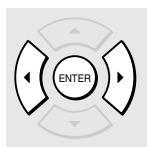

"Initial settings" menu returns.

Notes

- This recorder is provided with a calendar extending to 2069. (However, this does not mean that the recorder is supported to 2069.)
- To go back to the previous menu, press O button.
- To exit the menu, press SETUP button.

"2: Time and date setting" is complete. Go to "3: Channel setting". (→ page 40)

3: Channel setting

The recorder scans through all receivable TV and cable channels and stores only active ones in its memory. Once this process is completed, you can select a desired channel using CH buttons.

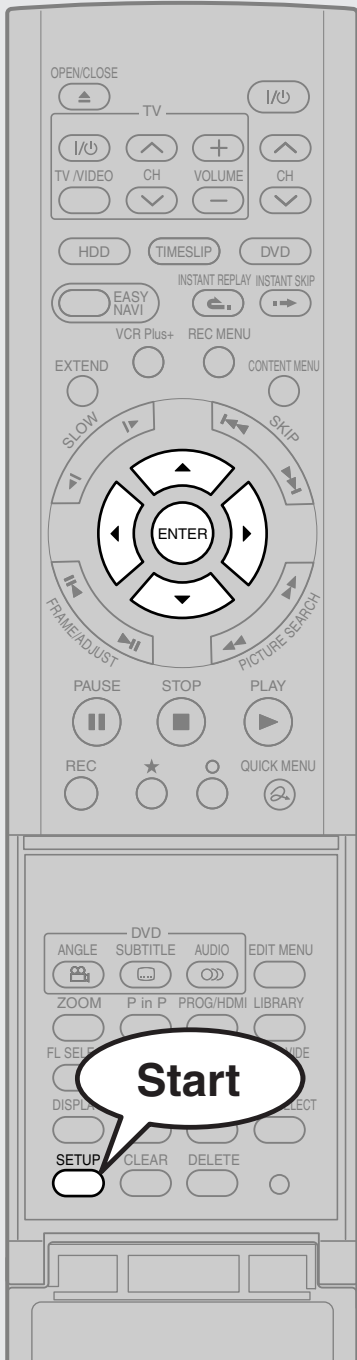

1 Press **SETUP**.

2 Press **◀/▶** to select “Initial settings”, then press **ENTER**.

3 Press **▲/▼** to select “TV/Cable”, then press **ENTER**.

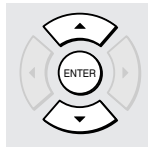

e.g.

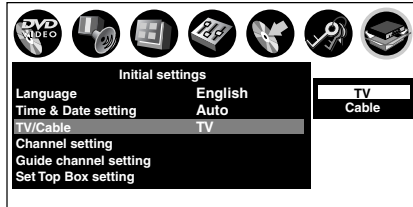

4 Press **▲/▼** to select “TV” or “Cable”, then press **ENTER**.

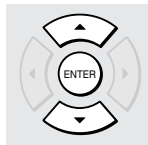

TV : To store broadcast channels received via the antenna.

Cable : To store channels received via cable.

5 Press **▲/▼** to select “Channel setting”, then press **ENTER**.

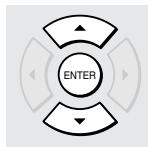

e.g.

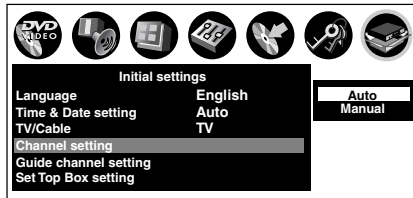

6 Press ▲ / ▼ to select “Auto”, then press ENTER.

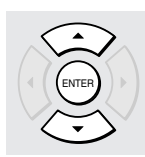

The recorder starts scanning and active channels are stored in the recorder in ascending order. The display returns to the previous screen after setting is completed.

■ Adding or erasing channels

Adding channels

If a desired channel cannot be scanned automatically because of a weak signal, it can be added to the memory.

Erasing channels

You can erase a stored channel from the memory.

- 1) Select “Manual” at step 6.
- 2) Press ▲ / ▼ to select a channel you want to add or erase.

For cable channels, refer to the chart below.

- 3) Press ADJUST (◀▶) to select “Add” or “Erase”.

Add : Adding channels
Erase : Erasing channels

e.g.

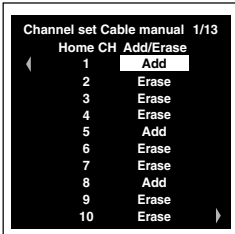

- 4) Press ENTER.

The confirmation message appears. Press ◀/▶ buttons to select “Yes”, then press ENTER button.

Channel reference

Number on the recorder	CH NUMBER	1	2	3	4	5	6	7	8	9
Corresponding channel number	TV	—	2	3	4	5	6	7	8	9
	Cable STD (HRC/IRC)	1(A-8)	2	3	4	5(A-7)	6(A-6)	7	8	9

10	11	12	13	14	15	16	17	18	19	20	21	22	23	24	25	26	27	28	29	30
10	11	12	13	14	15	16	17	18	19	20	21	22	23	24	25	26	27	28	29	30
10	11	12	13	A	B	C	D	E	F	G	H	I	J	K	L	M	N	O	P	Q

31	32	33	34	35	36	37	38	39	40	41	42	43	44	45	46	47	48	49	50	51
31	32	33	34	35	36	37	38	39	40	41	42	43	44	45	46	47	48	49	50	51
R	S	T	U	V	W	AA	BB	CC	DD	EE	FF	GG	HH	II	JJ	KK	LL	MM	NN	OO

52	53	54	55	56	57	58	59	60	61	62	63	64	65	66	67	68	69	70	71	...
52	53	54	55	56	57	58	59	60	61	62	63	64	65	66	67	68	69	—	—	...
PP	QQ	RR	SS	TT	UU	VV	WW	XX	YY	ZZ	AAA	BBB	65	66	67	68	69	70	71	...

93	94	95	96	97	98	99	100	101	102	103	...	121	122	123	124	125
—	—	—	—	—	—	—	—	—	—	—	...	—	—	—	—	—
93	94	A-5	A-4	A-3	A-2	A-1	100	101	102	103	...	121	122	123	124	125

Cable signals

- STD (standard) cable TV signals
- HRC (Harmonic Related Carriers) cable TV signals
- IRC (Incremental Related Carriers) cable TV signals
- IRC is also called ICC (Incremental Coherent Carriers)

“3: Channel setting” is complete. Go to “4: Set top box setting”. (➡ page 42)

A: Initial settings (Continued)

4: Set top box setting

For connecting a cable box or a satellite receiver to this recorder, follow the instructions below:

Preparation:

- To control channels of the connected set top box from the recorder, connect the supplied IR control cable to the CHANNEL CHANGE IR jack of the recorder. (➡ page 25)
- Confirm which type your connection is.

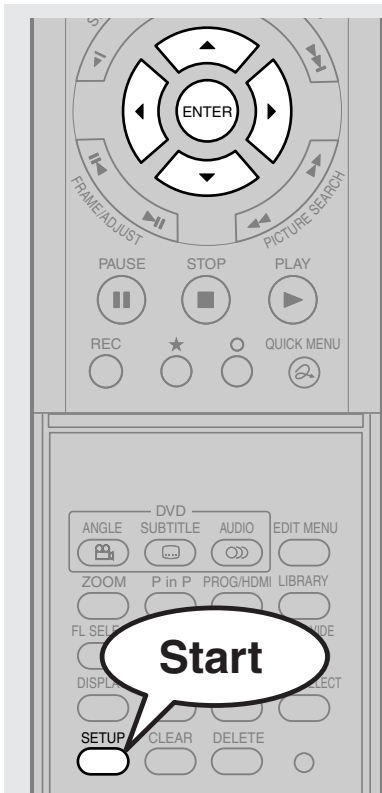
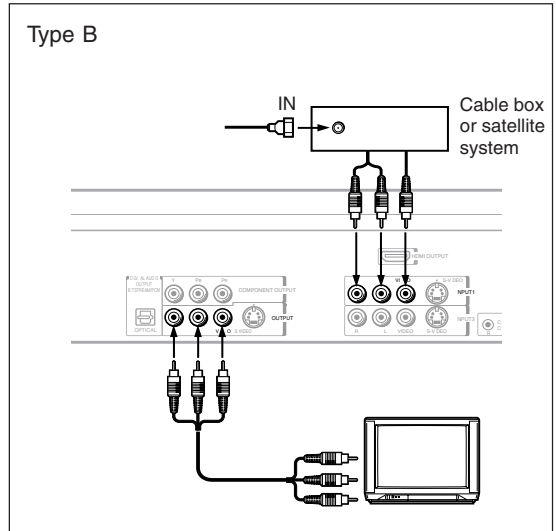
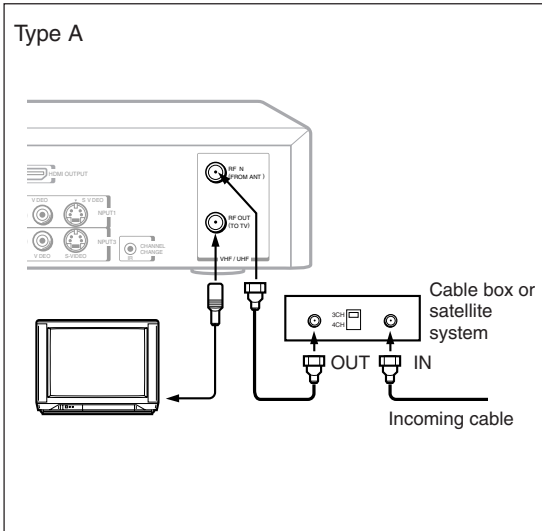

1 Press **SETUP**.

2 Press **◀/▶** to select “Initial settings”, then press **ENTER**.

3 Press **▲/▼** to select “Set Top Box setting”, then press **ENTER**.



e.g.

Set Top Box setting	
Cable Box/ DBS	Not used
Select Input	3CH
IR control	Off
Brand type	0 0 0



4 Press ADJUST (or ◀/▶) to select the type of set top box connected to this recorder.

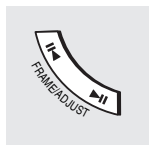

If you do not connect a set top box, select "Not used" then press ENTER button. Skip to step 9.

C.Box: When a cable box is connected.
DBS: When a satellite system is connected.

5 Press ▼.

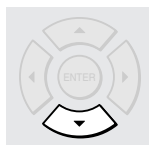

e.g.

Set Top Box setting	
Cable Box/ DBS	C.Box
Select Input	3CH
IR control	Off
Brand type	0 0 0

6 Press ADJUST (or ◀/▶) to select the way the signal will be input from the set top box.

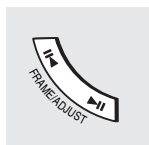

3CH : For type A connection with the output channel number 3 of the set top box.

4CH : For type A connection with the output channel number 4 of the set top box.

Line1 : For type B connection via the INPUT1 jacks using the audio/video cable.

Line3 : For type B connection via the INPUT3 jacks using the audio/video cable.

7 Press ▼, then press ADJUST (or ◀/▶) to select "Off" or "On".



Off : Channels of the set top box are selected by its own selector. Skip to step 9.

On : The recorder can change channels of the set top box.
(Be sure to make the connection to the CHANNEL CHANGE IR jack (▶ page 25). If you make timer program recording, keep the set top box powered on to have it receive commands from the recorder.)

(Continued)

A: Initial settings (Continued)

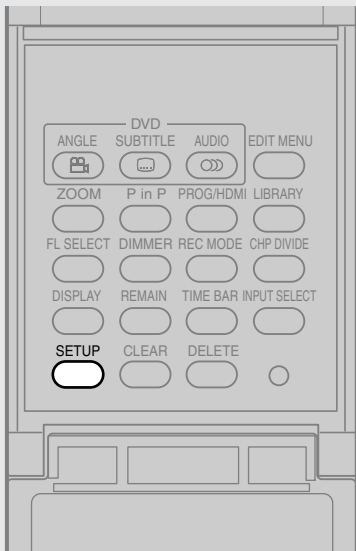
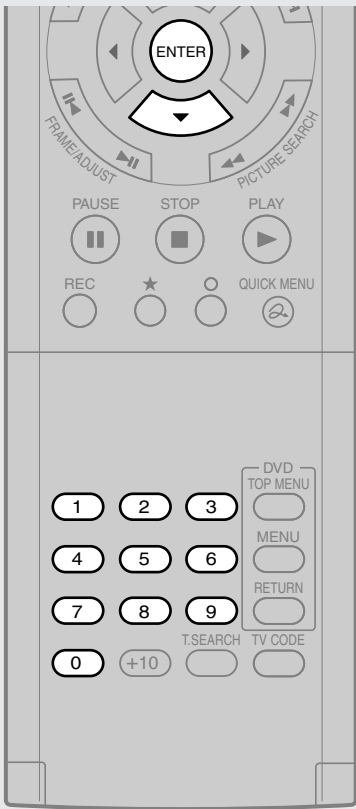

8 Press **▼**, then press the number buttons to enter the 3 digits of a brand code of your set top box obtained from the table (➡ page 45).

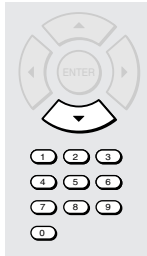

e.g. If you connect a TOSHIBA satellite receiver:

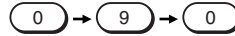

9 Press **ENTER**.



“Initial settings” menu returns.

10 Press **SETUP**.



“Initial settings” menu disappears.

If you have selected to have the recorder control your set top box at step 7, turn on your set top box and confirm that set top box channels are selected by the number buttons or CH buttons of the recorder’s remote control. If not, shift the transmitter of the IR control cable or try another brand code at step 8.

“4: Set top box setting” is complete. Go to “5: Guide channel setting”. (➡ page 46)

■ Set top box brand code

Brands	Codes					Brands	Codes							
Archer	044	006	001			Oak	046	011						
Cable Cinema	029	009	001	063		Oak Sigma	046	011						
Cabletenna	029	009	001	063		Optimus DSS	094	095						
Cableview	029	009	001	063		Panasonic	017	016	008					
Centurion	044	051	075	059	076	Panasonic DSS	096							
	078					Philips	023	024	020	013	075			
Century	044	051	075	059	076	Philips DSS	091	099	102	105				
	078					Pioneer	006	005	012					
Citizen	044	052	030			Primestar DSS	092	100						
Clearview	074	035	021			ProScan DSS	097	103						
Curtis	008	009	025	061	053	Pulser	004	042						
Diamond	029	009	001	063		Quest	006	005	012					
Drake DSS	093					Radio Shack	044	051	075	059	076			
Eagle	062	040	022	013	058		078							
	020					RCA DSS	097	103						
Eastern	028	029				RCA	017	016	008					
Echostar DSS	092	100				Realistic	044	051	075	059	076			
Explorer	008	009	025	061	053		078							
GC Electronics	044	042	063	029		Recoton	044	051	075	059	076			
Gemini	030	004					078							
General Electric	001	057				Regal	041	014	015	028				
General Instrument	001	083	034	003	002	Regency	028	029						
	004	084	055	065	066	Rembrandt	044	042	063	029				
	067	068	069			Samsung	042	006	032					
Gerrard	044	051	075	059	076	Samsung DSS	097	103						
	078					Scientific Atlanta	008	009	025	061	053			
Hamlin	041	014	015	028		Sheritech	027							
Hitachi	031					Signal	026	075						
Hitachi DSS	091	099	102	105		SL Marx	042	006	032					
Hughes DSS	091	099	102	105		Sony	010							
Jasco	030	004				Sony DSS	098							
Jerrold	001	083	034	003	002	Sprucer	017	016	008					
	004	084	055	065	066	Standard Components	032	039						
	067	068	069			Stargate	004	042						
Macom	031					Sylvania	019	018						
Maestro	074	035	021			Teknika	074	035	021					
Magnavox	026	075				Telecaption	077							
Magnavox DSS	094	095				Teleview	040	019	038	032				
Matsushita	017	016	008			Texscan	019	018						
Motorola	001	083	034	003	002	Tocom	034	033	001	042	066			
	004	084	055	065	066	Toshiba	036							
	067	068	069			Toshiba DSS	090							
Movietime	032	039				Uniden DSS	094	095						
NEC	040	019	038	032		Unika	044	042	063	029				
Next Level	100	083	034	003	002	Universal	052	043	044	063				
	004	084	055	065	066	Videoway	007	023	050					
	067	068	069			Vidtek	064							
Novaplex	044	051	075	059	076	Viewstar	062	040	022	013	058			
	078						020							
Novavision	008	009	025	061	053	Zenith	007	023	050					
NSC	040	019	038	032		Zenith HDS	101							

A: Initial settings (Continued)

5: Guide channel setting

VCR Plus+ system is a timer recording system designed to simplify programming. It requires you to enter a PlusCode® programming number corresponding to a desired program. You must program the recorder for the special numbers for guide channels (also called VCR Plus+ system channel numbers) assigned to each channel that you receive. The recorder identifies the channel for recording by the guide channel number you enter. The guide channel numbers are published in TV guide magazine, selected local TV publications, or in the channel guide from cable company. If you cannot find the VCR plus numbers, call Gemstar's customer service department at 1-800-4321-VCR or visit their website at www.vcrplus.com.

* VCR Plus+, C³ and PlusCode are registered trademarks of Gemstar Development Corporation. The VCR Plus+ system is manufactured under license from Gemstar Development Corporation.

Sample of a Guide channel chart from a local TV listing

VCR Plus+® SYSTEM CHANNEL NUMBERS			
Broadcast channels	Assigned channels	Cable channels	Assigned channels
3 KCRA (NBC)	3	A & E	39
6 KVIE (PBS)	6	AMC	35
10 KXTV (CBS)	10	BET	57
13 KOVR (ABC)	13	BRAV	54
19 KCOS (SPAN)	19	CMTV	14
31 KRBK (IND)	31	CNBC	23
40 KTXL (FOX)	40	CNN	42
58 KSCH (IND)	25	C-SPAN	28
44 KBHK (IND)	15	CUNY	29
24 KCPM (NBC)	24	DIS	53
4 KRNV (NBC)	28	ESPN	34
42 KFCB (IND)	27	FAM	47
7 KGO (ABC)	28	HBO	33

Sample of a Channel line-up chart from a cable-TV company

CHANNEL LINE-UP CHART	
Channel 2	ME/U
Channel 3	8 WISH
Channel 4	4 WTTV
Channel 5	6 WRTV
Channel 6	VCA/Local origination
Channel 7	HOME BOX OFFICE
Channel 8	A.P News Plus
Channel 9	9 WGN.

Preparation

- If you record cable/satellite channels, finish the set top box setting. ➡ page 42
- Prepare the list like below.

Example

Station	Guide channel number (on the TV Guide, local TV listings etc.)	Your home channel number (on the channel line-up chart supplied by cable companies)
HBO	33	7
ESPN	34	
AMC	35	



1 Press **SETUP**.

2 Press **◀/▶** to select "Initial settings", then press **ENTER**.

3 Press **▲/▼** to select "Guide channel setting", then press **ENTER**.

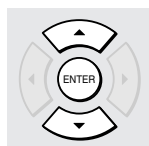

"Guide channel setting" menu appears.

4 Press ▲ / ▼ to find a guide channel number you marked on the list.

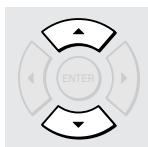

e.g. guide channel number 33 (HBO)

e.g.

Guide channel setting		4/13
Guide CH	Home CH	
31	31	
32	32	
33	33	
34	34	
35	35	
36	36	
37	37	
38	38	
39	39	
40	40	

5 Press the number buttons or ADJUST (◀▶) to set the corresponding home channel number.

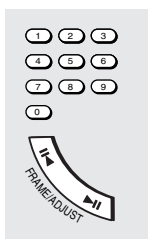

e.g. home channel number 7 (HBO)

e.g.

Guide channel setting		4/13
Guide CH	Home CH	
31	31	
32	32	
33	7	
34	34	
35	35	
36	36	
37	37	
38	38	
39	39	
40	40	

In some areas, a channel may be assigned more than one guide channel number. In this case, enter the home channel number to each of the guide channel numbers.

6 Press ENTER.

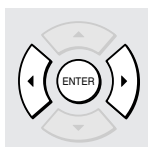

The confirmation message appears. Press ◀ / ▶ buttons to select “Yes”, then press ENTER button.



Note

- If you change the settings on “3: Channel setting” or “4: Set top box setting” (▶ page 40-45), the guide channels you have set may change. After you changed these settings, be sure to check “Guide channel setting” again, and correct the setting, if necessary.

B: Output sound setting

Select the output sound setting corresponding to the connected TV or audio system.



1 Press SETUP to display the setup menu.



When it is already displayed, press O button.

2 Press ◀/▶ to select “Picture/Audio settings”, then press ENTER.

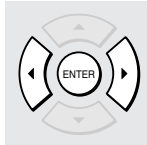

e.g.

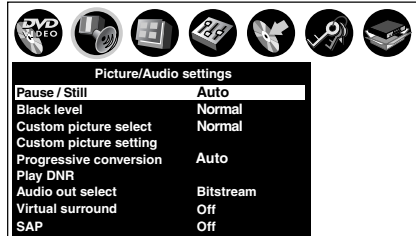

3 Press ▲/▼ to select “Audio out select”, then press ENTER.

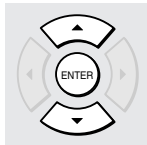

e.g.

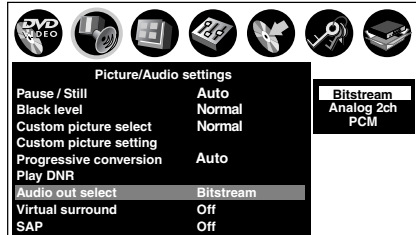

4 Press ▲ / ▼ to select the output sound format.

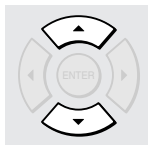

Bitstream:

Select when connected to an amplifier equipped with a Dolby Digital, DTS, MPEG1 and MPEG2 decoder. (➡ page 29)

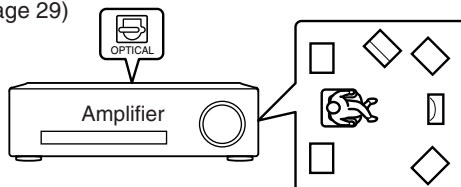

The recorder outputs digital audio information in the bitstream format when you play a DVD video disc recorded on the Dolby Digital, DTS, MPEG1 and MPEG2 recording system.

Analog 2ch:

Select when connected to a TV or audio system via the analog audio jacks. (➡ pages 21, 28)

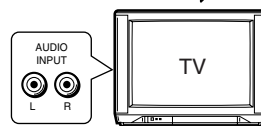

PCM:

Select when connected to a 2 channel digital stereo system. (➡ page 29)

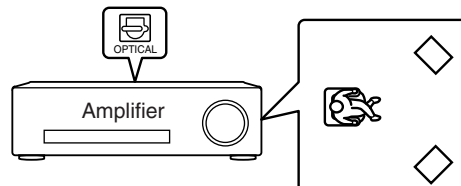

The recorder outputs sounds in the PCM 2ch format when you play a disc recorded on the Dolby Digital, MPEG1 and MPEG2 recording system.

5 Once the proper setting is selected, press ENTER.



The submenu disappears.

To exit the setting menu, press SETUP button.

“B: Output sound setting” is complete. Go to “C: TV shape setting”. (➡ page 50)

C: TV shape setting

Select the picture shape according to the aspect ratio of your TV.



1 Press SETUP to display the setup menu.

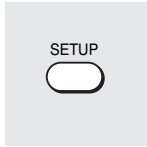

When it is already displayed, press O button.
(To return to the previous menu)

2 Press ◀/▶ to select “Display settings”, then press ENTER.

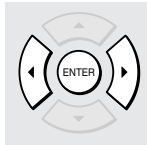

e.g.

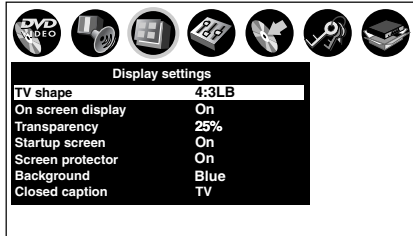

3 Press ▲/▼ to select “TV shape”, then press ENTER.



e.g.

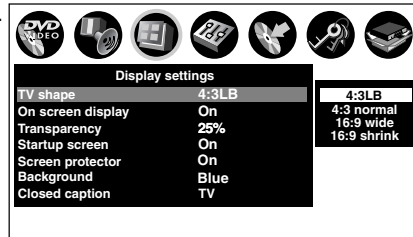

4 Press ▲ / ▼ to select the picture shape.

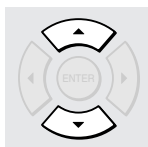

4:3 LB:

Select when a standard 4:3 TV is connected. Displays theatrical images with masking bars above and below the picture.



4:3 normal:

Select when a standard 4:3 TV is connected. Displays pictures cropped to fill your TV screen. Either or both of the picture's sides are cut off.



16:9 wide:

Select when a 16:9 wide TV is connected.

16:9 shrink:

Select when a 16:9 wide TV is connected. When a 4:3 aspect ratio image has been elongated to 16:9 wide picture size, use this setting. Masking bars to the right and left appears.



5 When the proper setting is selected, press ENTER.

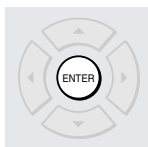

The submenu disappears. To exit the setting menu, press SETUP button.

Notes

- Actual picture shape may depend on signal types of broadcasts or input sources, or settings on the connected TV. Refer to the owner's manual of your TV.
- When a DVD video disc has a particular available picture shape, the contents may not be compatible with other picture shapes.

“C: TV shape setting” is complete. Go to “D: Remote control settings”. (➡ page 52)

D: Remote control settings

Take this step according to your preference and usage.

Operating a TV with the remote control of this recorder

The remote control of this recorder has a function to operate a TV.

Preparation: Please find the brand code on the next page for the TV you wish to control.



1 While holding **TV CODE**, press the number buttons to enter a corresponding brand code (see the next page) of your TV.

e.g. To enter 0071

TV CODE





TV CODE

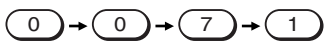

Hold down.

0 → 0 → 7 → 1





2 Release **TV CODE**.

The brand code is memorized.

■ Operating your TV with the remote control

Point the remote control to your TV after you have entered the brand code. Operate your TV with the buttons below.

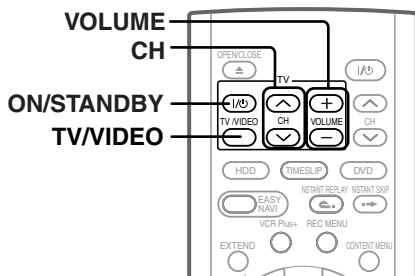

- ON/STANDBY:** To turn on and off the TV
- TV/VIDEO** : To change the video input
- CH** : To select the TV channel
- VOLUME** : To adjust the volume

Brand code table

Brand name	Brand code					Brand name	Brand code				
Toshiba	0001	0021	0071	0311	0411	Philco	0051	0161	0271	0291	0361
	0431	0831	0841	0851	1341		0421	0501	0551	0621	0631
	1611	1621	1681	1781	1951		0661	0711			
	2121	2461	2491								
Bell & Howell	0081	0431				Philips	0051	0161	0271	0321	0361
	0051	0381	0471	0551	0621		0421	0461	0551	0631	0661
Citizen	0851	1561					0711	2141	2351		
	0051	0391	0431	0531	0621	Proton	0051	0161	0621	0651	2491
Curtis Mathes	0851	1521	1561	2501			Quasar	0711	0741	0801	1401
	0051	0111	0121	0141	0151	Radio Shack		0431	1521	2481	
Emerson	0161	0201	0211	0351	0381		Radio Shack/Realistic	0051	0161	0381	0391
	0431	0521	0561	0571	0621	0541		0621	1431	1561	2501
	0691	1241	1291	1371	1561	RCA	0051	0221	0391	0501	0621
	2481						0661	0711	0871	0881	0911
Fisher	0251	0401	0431	1151	2451		0921	0941	1001	1041	1071
	2481						1091	1181	1211	1241	1301
GE	0041	0051	0091	0181	0321		1461	1491	1521	1531	2291
	0371	0391	0591	0621	0711		2481	2501			
	0741	0881	1041	1471	1521	Realistic	0431	1521			
	2481	2501					Runco	0011			
Goldstar	0051	0061	0161	0231	0451	Samsung		0051	0161	0501	0531
	0501	0621	0661	0771	0961		0661	0851	0931	1021	1141
	1431	1561	2481				1431	1561	1591	1601	1771
Hallmark	0051	0621					1811	1821	1831	1841	1851
	2381	0031	0051	0161	0191	Sanyo	1861	1931	2081	2101	2311
Hitachi	0301	0601	0621	0641	0671			0051	0261	0401	0431
	0811	0821	0951	1011	1061		0901	1151	2461		
	1241	1361	1651	1711	1731	Sears	0001	0051	0151	0191	0251
	1741	1751	1761	2041	2051		0311	0331	0391	0401	0411
	2131					0431	0621	0661	1041	1081	
Infinity	0631						1151	1481	1521	2461	2481
JBL	0631						2501				
JVC	0101	0161	0191	0241	0331	Sharp	2181	0051	0111	0161	0351
	0511	0561	0601	0741	0991		0541	0581	0611	0621	0731
	1321	1421	2161	2171	2261		0891	1101	1561	1721	1871
LXI	0001	0311	0391	0411	0431	Sony	1881	1941	2341		
	0621	0631	1041	1171	1521		1231	0441	1111	1511	2411
	2491	2501					1891	1901	2061	2421	2431
Magnavox	0051	0271	0291	0341	0361	Soundesign	2401				
	0421	0551	0621	0631	0661		0051	0151	0381	0551	0621
	0971	0981	1131	2221	2351		2481				
Marantz	0051	0481	0621	0631	0641	Sylvania	0051	0071	0271	0291	0341
	2491						0361	0421	0551	0621	0631
Memorex	0081	0431	0501	0621	2491	Tandy	0661	0861	1441	2191	2201
	0051	0251	0261	0371	0501		1101				
MGA	0621	0661	0761			Technics	0741				
	0051	0251	0261	0281	0371		Teknika	0051	0081	0151	0161
Mitsubishi	0491	0501	0621	0661	0761			0341	0381	0471	0501
	2231	2241					0621	0851	1271	1401	1561
	0051	0501	0621	0851			2481				
MTC	0001	0311	0411	0621	1061	Wards	0051	0081	0141	0151	0181
	0541	1101					0211	0271	0321	0341	0361
Panasonic	2301	0631	0711	0741	1271		0391	0421	0501	0541	0621
	1351	1401	1501	1701	1791		0631	0661	1051	1521	2491
	1801	2111	2151				2501				
						Zenith	0011	0051	0081	0781	1281
							1571	2091	2211	2251	2391
							2361	2441			

Notes

- TOSHIBA code is already set when you operate this recorder for the first time.
- Some brands have several codes. Try one by one until the remote control can operate your TV.
- Even after the recorder's remote control is programmed, it may not operate some or all of the features on your other device. If this happens and you wish to use those features, you will need to use the device's original remote control.
- When replacing the batteries of the remote control, re-enter the brand code of your TV.

Operating the second and third TOSHIBA HDD/DVD video recorders with the remote control of this recorder

Switches the codes to operate the recorder.

If you use the second and third TOSHIBA HDD/DVD video recorders, set the different remote codes for each recorder to avoid confusion in the response of the recorders.

Example: Setting this recorder's remote control mode to DR 2, after another HDD/DVD recorder has been set to DR 1.

(It is necessary to set the remote control mode on both the recorder and the remote control.)

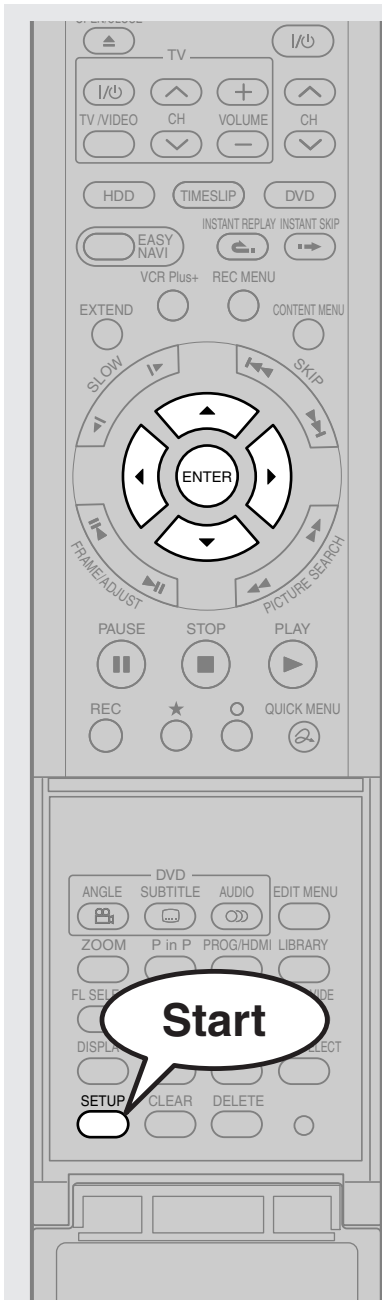

Setting up the recorder

1 Press SETUP.



The setting menu appears.

2 Press ◀/▶ to select “Operational settings”, then press ENTER.

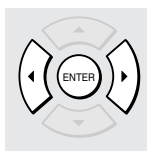

e.g.

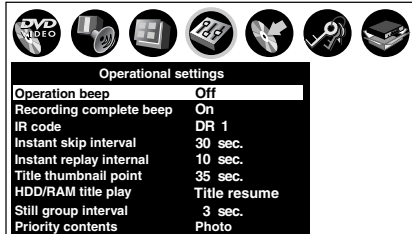

3 Press ▲/▼ to select “IR code”, then press ENTER.

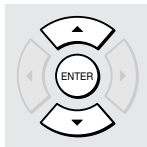

e.g.

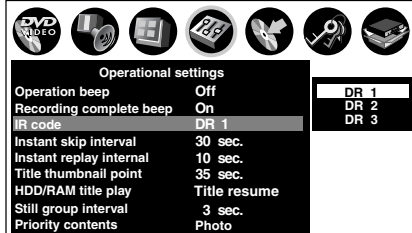

4 Press ▲/▼ to select “DR 2” (example), then press ENTER.

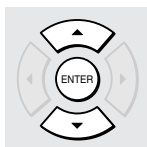

The submenu disappears. Press ENTER button and the IR code you selected is activated. Operation may not be possible temporarily until you set the corresponding mode of the remote control. Proceed to the next setting.



Setting up the remote control

5 While pressing EASY NAVI, press 2.

The remote control mode is set to "DR 2".



Select the same mode that you have set to the recorder.

	Mode setting	
	Recorder	Remote control
When using with DR 1 mode		
When using with DR 2 mode		
When using with DR 3 mode		

Notes

- If the recorder's mode and the remote control's mode are different, the recorder's mode (DR 1, DR 2 or DR 3) appears on the display of the front panel.
- When the batteries of the remote control are replaced or when the time indicator of the front panel flashes, check the remote control modes of both the recorder and the remote control, and re-program it if necessary.

■ Disabling the remote control for a temporary period

You can temporarily disable the reception of the remote control signals at the recorder, when the selection of DR 1, DR 2 and DR 3 is not sufficient while you are using several Toshiba HDD/DVD video recorders.

Press CH buttons on the recorder at the same time for three seconds or more.

The recorder display shows "DR - OFF", indicating that the remote control is disabled.

To enable the remote control, perform the same step again. (The display shows "DR-1", "DR-2" or "DR-3" depending on your setting.)

Note

- This function is not available in Standby mode.
- You cannot use this feature when the power is turned off, if you have turned "On" the "Eco. mode" on the menu.

Limited Warranty DVD PLAYER/RECORDER

Toshiba America Consumer Products, L.L.C., ("TACP") makes the following limited warranties to original consumers in the United States. THESE LIMITED WARRANTIES EXTEND TO THE ORIGINAL CONSUMER PURCHASER OR ANY PERSON RECEIVING THIS DVD PLAYER/RECORDER AS A GIFT FROM THE ORIGINAL CONSUMER PURCHASER AND TO NO OTHER PURCHASER OR TRANSFEREE.

PRODUCTS PURCHASED IN THE U.S.A. AND USED IN CANADA ARE NOT COVERED BY THESE WARRANTIES.

PRODUCTS PURCHASED IN CANADA AND USED IN THE U.S.A. ARE NOT COVERED BY THESE WARRANTIES.

Limited Ninety (90) Day Warranty on Labor*

TACP warrants this DVD PLAYER/RECORDER and its parts against defects in materials or workmanship for a period of ninety (90) days after the date of original retail purchase. DURING THIS PERIOD, TACP WILL, AT TACP'S OPTION, REPAIR OR REPLACE A DEFECTIVE PART WITH A NEW OR REFURBISHED PART WITHOUT CHARGE TO YOU FOR PARTS OR LABOR. YOU MUST DELIVER THE ENTIRE DVD PLAYER/RECORDER TO AN AUTHORIZED TACP SERVICE STATION. YOU MUST PAY FOR ALL TRANSPORTATION AND INSURANCE CHARGES FOR THE DVD PLAYER/RECORDER TO AND FROM THE SERVICE STATION.

Limited One (1) Year Warranty on Parts*

TACP further warrants the parts in this DVD PLAYER/RECORDER against defects in materials or workmanship for a period of one (1) year after the date of original retail purchase. DURING THIS PERIOD, TACP WILL, AT TACP'S OPTION, REPAIR OR REPLACE A DEFECTIVE PART WITH A NEW OR REFURBISHED PART WITHOUT CHARGE TO YOU FOR THE PART, PROVIDED THAT IF A DEFECTIVE PART IS REPAIRED OR REPLACED AFTER NINETY (90) DAYS FROM THE DATE OF ORIGINAL RETAIL PURCHASE, THE CONSUMER SHALL PAY ALL LABOR CHARGES INVOLVED IN THE REPAIR OR REPLACEMENT OF SUCH PART. YOU MUST DELIVER THE ENTIRE DVD PLAYER/RECORDER TO AN AUTHORIZED TACP SERVICE STATION. YOU MUST PAY FOR ALL TRANSPORTATION AND INSURANCE CHARGES FOR THE DVD PLAYER/RECORDER TO AND FROM THE SERVICE STATION.

*Rental Units

The warranty for rental units begins with the first rental or thirty (30) days from the date of shipment to the rental firm, whichever comes first.

*Commercial Units

DVD PLAYER/RECORDER(s) sold and used for commercial purposes have a limited ninety (90) day warranty.

Owner's Manual and Product Registration

Read this owner's manual thoroughly before operating this DVD Player/Recorder.

Complete and mail the enclosed product registration card or register your product on-line at www.tacp.toshiba.com/ service as soon as possible. By registering your product you will enable TACP to bring you new products specifically designed to meet your needs and help us to contact you in the unlikely event a safety notification is required under the Consumer Product Safety Act. Failure to complete and return the product registration card does not diminish your warranty rights.

Your Responsibility

THE ABOVE WARRANTIES ARE SUBJECT TO THE FOLLOWING CONDITIONS:

- (1) You must provide your bill of sale or other proof of purchase.
- (2) All in-warranty servicing of this DVD PLAYER/RECORDER must be made by a specified Authorized TACP Service Station.
- (3) The warranties from TACP are effective only if the DVD PLAYER/RECORDER is purchased and operated in the U.S.A. or Puerto Rico.
- (4) Labor service charges for set installation, set up, adjustment of customer controls and installation or repair of hook up related items and/or antenna systems are not covered by these warranties. Reception problems caused by inadequate antenna systems are your responsibility.
- (5) Warranties extend only to defects in materials or workmanship as limited above and do not extend to any DVD PLAYER/RECORDER or parts which have been lost or discarded by you or to damage to DVD PLAYER/RECORDER or parts caused by fires, misuse, accident, Acts of God, such as lightning or fluctuations in electric power, improper installation, improper maintenance or use in violation of instructions furnished by TACP; or to units which have been modified or had the serial number removed, altered, defaced or rendered illegible.

How to Obtain Warranty Services

If, after following all of the operating instructions in this manual and checking the section "Troubleshooting", you find that service is needed:

- (1) To find the nearest TACP Authorized Service Station, visit TACP's website at www.tacp.toshiba.com/service or call toll-free 1-800-631-3811.
- (2) Present your bill of sale or other proof of purchase to the TACP Authorized Service Station.

For additional information, visit TACP's web site:
www.tacp.toshiba.com.

ALL WARRANTIES IMPLIED BY THE LAW OF ANY STATE OF THE U.S.A., INCLUDING THE IMPLIED WARRANTIES OF MERCHANTABILITY AND FITNESS FOR A PARTICULAR PURPOSE, ARE EXPRESSLY LIMITED TO THE DURATION OF THE LIMITED WARRANTIES SET FORTH ABOVE. WITH THE EXCEPTION OF ANY WARRANTIES IMPLIED BY THE LAW OF ANY STATE OF THE U.S.A. AS HEREBY LIMITED, THE FOREGOING WARRANTY IS EXCLUSIVE AND IN LIEU OF ALL OTHER WARRANTIES, GUARANTEES, AGREEMENTS, AND SIMILAR OBLIGATIONS OF TACP WITH RESPECT TO THE REPAIR OR REPLACEMENT OF ANY PARTS. IN NO EVENT SHALL TACP BE LIABLE FOR CONSEQUENTIAL OR INCIDENTAL DAMAGES (INCLUDING, BUT NOT LIMITED TO, LOST PROFITS, BUSINESS INTERRUPTION, OR MODIFICATION OR ERASURE OF RECORDED DATA CAUSED BY USE, MISUSE OR INABILITY TO USE THIS PRODUCT).

No person, agent, distributor, dealer or company is authorized to change, modify or extend the terms of these warranties in any manner whatsoever. The time within which action must be commenced to enforce any obligation of TACP arising under this warranty or under any law of the United States or of any state thereof is hereby limited to 90 days from the date you discovered or should have discovered, the defect. This limitation does not apply to implied warranties arising under the law of any state of the U.S.A.



- IMPORTANT - CANADIAN WARRANTY INFORMATION GARANTIE CANADIENNE

STANDARD WARRANTY
TYPE OF SET

DVD Player
DVD/VCR Combination
Home Theatre in a Box
DVD Recorder
Portable DVD

GARANTIE NORMALE
TYPE D'APPAREIL

Lecteur DVD
DVD/magnétoscope combo
Cinéma maison dans une boîte
Enregistreur DVD
DVD Portatif

WARRANTY PERIOD

12 MONTHS

DURÉE DE LA GARANTIE:

12 MOIS

CANADIAN WARRANTY

Toshiba of Canada Limited (TCL) makes the following limited warranties to original consumers in Canada. Please retain your "Bill of Sale" as proof of purchase. **To obtain a "Canadian Warranty" please register online at www.toshiba.ca.**

GARANTIE CANADIENNE

1) Toshiba du Canada Limitée (TCL) offre au Canada les garanties limitées suivantes aux consommateurs originaux. Veuillez conserver votre « facture » comme preuve d'achat. **Pour obtenir une garantie canadienne, veuillez vous inscrire en ligne à www.toshiba.ca**

Canadian Warranty Information

Should service be required on this unit during the one year warranty period, TCL's option will be to repair or exchange the defective unit. It will be necessary to follow this procedure:

Contact: Toshiba of Canada Limited at the Consumer Electronics Group, customer support line.

Phone: 1-800-268-3404

Email: ceg_customer_support@toshiba.ca

Information sur la garantie Canadienne

Si vous avez besoin de service sur cet appareil au cours de l'année de garantie, Toshiba du Canada Limitée aura l'option de réparer ou échanger l'appareil défectueux. Vous devrez suivre la procédure suivante:

Contact: Toshiba du Canada Limitée au Groupe Électronique aux consommateurs, service à la clientèle.

Tél: 1-800-268-3404

Courriel: ceg_customer_support@toshiba.ca

All in-warranty repairs must be made by an authorized TCL service centre.

Toutes les réparations au cours de la garantie doivent être faites par un centre de service autorisé Toshiba.

For service exchange TCL will arrange to have the unit picked up by courier and a replacement unit will be returned via same courier. (Note: A major credit card number will be required as a charge of \$25.00 will apply if no fault is found with the unit.) During the first 3 months of ownership, a new unit will be supplied as a replacement. During the remainder of the warranty period a service-renewed unit will be supplied. The original "Bill of Sale" must be provided as proof of purchase (it will be returned with the replacement unit.)

This 12-month warranty will be strictly adhered to.

Out of warranty units should be repaired by a TCL authorized service centre.

Note: It is the responsibility of the owner to ensure proper packaging. Should damage in shipping occur, due to poor packaging, a charge back for the repair will result. This warranty applies to the original purchaser only and is not transferable.

This warranty does not apply to sets that have been subjected to misuse, neglect, accident, physical damage or acts of nature.

Sets with the serial number removed, altered, replaced or defaced will not be covered by this warranty.

The warranties from TCL are effective only if the product is purchased in Canada from an authorized TCL dealer and operated in Canada.

Products utilized for rental or commercial purposes are not covered by this warranty.

This warranty is in lieu of all other warranties, guarantees or agreements, whether expressed or implied, and no person, agent distributor, dealer, service centre or company is authorized to change, modify or extend its terms in any manner whatsoever.

Pour un échange TCL s'assurera qu'un service de courrier ramassera l'unité et qu'un appareil de remplacement soit expédié par le même service de courrier.

(Note: Un numéro de carte de crédit sera requis car une charge de 25,00\$ sera appliquée si toutefois l'appareil n'avait aucun problème de fonctionnement.)

Une nouvelle unité sera fournie comme remplacement durant les premiers 3 mois de propriété. Par contre durant la balance de la garantie une unité remise à neuf sera fournie.

La «facture» originale doit être fournie comme preuve d'achat (elle vous sera retournée avec l'unité de remplacement.)

Cette garantie de 12 mois sera strictement adhéree.

Les unités hors de garantie devraient être réparées par un centre de service autorisé Toshiba.

Note: C'est la responsabilité du propriétaire de s'assurer que l'emballage est adéquat. Vous serez facturé pour toutes réparations causées par des dommages encourus à cause d'un emballage non adéquat.

Cette garantie est octroyée à l'acheteur initial et n'est pas transférable. Cette garantie ne s'applique pas aux appareils qui ont été sujets aux abus, négligences, accidents, dommages physiques ou actes naturels.

Les appareils dont le numéro de série a été enlevé, altéré, remplacé ou barbouillé ne sont pas couverts par cette garantie.

Les garanties de TCL sont valides seulement sur les unités sont achetées et utilisées au Canada d'un marchand autorisé TCL.

Cette garantie ne couvre pas les produits de location ou à usage commercial. Cette garantie remplace toutes autres garanties ou ententes exprimées ou sous-entendues. Aucune personne, agent, distributeur, concessionnaire ou compagnie n'est autorisée à changer, modifier ou prolonger les termes de cette garantie de quelque façon que ce soit.

Memo

Introduction

Connections

Basic Setup

TOSHIBA



Printed on 70% Recycled Paper

Printed in China